

Intel® Desktop Board DQ45CB Product Guide

Order Number: E37720-001

Revision History

Revision	Revision History	Date
-001	First release of the Intel® Desktop Board DQ45CB Product Guide	June 2008

If an FCC declaration of conformity marking is present on the board, the following statement applies:

FCC Declaration of Conformity

This device complies with Part 15 of the FCC Rules. Operation is subject to the following two conditions: (1) this device may not cause harmful interference, and (2) this device must accept any interference received, including interference that may cause undesired operation.

For questions related to the EMC performance of this product, contact:

Intel Corporation, 5200 N.E. Elam Young Parkway, Hillsboro, OR 97124
1-800-628-8686

This equipment has been tested and found to comply with the limits for a Class B digital device, pursuant to Part 15 of the FCC Rules. These limits are designed to provide reasonable protection against harmful interference in a residential installation. This equipment generates, uses, and can radiate radio frequency energy and, if not installed and used in accordance with the instructions, may cause harmful interference to radio communications. However, there is no guarantee that interference will not occur in a particular installation. If this equipment does cause harmful interference to radio or television reception, which can be determined by turning the equipment off and on, the user is encouraged to try to correct the interference by one or more of the following measures:

- Reorient or relocate the receiving antenna.
- Increase the separation between the equipment and the receiver.
- Connect the equipment to an outlet on a circuit other than the one to which the receiver is connected.
- Consult the dealer or an experienced radio/TV technician for help.

Any changes or modifications to the equipment not expressly approved by Intel Corporation could void the user's authority to operate the equipment.

Tested to comply with FCC standards for home or office use.

Canadian Department of Communications Compliance Statement

This digital apparatus does not exceed the Class B limits for radio noise emissions from digital apparatus set out in the Radio Interference Regulations of the Canadian Department of Communications.

Le présent appareil numérique n'émet pas de bruits radioélectriques dépassant les limites applicables aux appareils numériques de la classe B prescrites dans le Règlement sur le brouillage radioélectrique édicté par le ministère des Communications du Canada.

Disclaimer

INFORMATION IN THIS DOCUMENT IS PROVIDED IN CONNECTION WITH INTEL® PRODUCTS. NO LICENSE, EXPRESS OR IMPLIED, BY ESTOPPEL OR OTHERWISE, TO ANY INTELLECTUAL PROPERTY RIGHTS IS GRANTED BY THIS DOCUMENT. EXCEPT AS PROVIDED IN INTEL'S TERMS AND CONDITIONS OF SALE FOR SUCH PRODUCTS, INTEL ASSUMES NO LIABILITY WHATSOEVER, AND INTEL DISCLAIMS ANY EXPRESS OR IMPLIED WARRANTY, RELATING TO SALE AND/OR USE OF INTEL PRODUCTS INCLUDING LIABILITY OR WARRANTIES RELATING TO FITNESS FOR A PARTICULAR PURPOSE, MERCHANTABILITY, OR INFRINGEMENT OF ANY PATENT, COPYRIGHT OR OTHER INTELLECTUAL PROPERTY RIGHT. Intel products are not intended for use in medical, life saving, or life sustaining applications. Intel may make changes to specifications and product descriptions at any time, without notice.

Intel Desktop Board DQ45CB may contain design defects or errors known as errata which may cause the product to deviate from published specifications. Current characterized errata are available on request. Contact your local Intel sales office or your distributor to obtain the latest specifications and before placing your product order.

Copies of documents which have an ordering number and are referenced in this document, or other Intel literature, may be obtained from Intel Corporation by going to the World Wide Web site at: <http://intel.com/> or by calling 1-800-548-4725.

Intel, the Intel logo, and Intel Viiv are trademarks of Intel Corporation in the U.S. and other countries.

* Other names and brands may be claimed as the property of others.

Copyright © 2008, Intel Corporation. All rights reserved.

Preface

This Product Guide gives information about board layout, component installation, BIOS update, and regulatory requirements for Intel® Desktop Board DQ45CB.

Intended Audience

The Product Guide is intended for technically qualified personnel. It is not intended for general audiences.

Use Only for Intended Applications

All Intel Desktop Boards are evaluated as Information Technology Equipment (I.T.E.) for use in personal computers (PC) for installation in homes, offices, schools, computer rooms, and similar locations. The suitability of this product for other PC or embedded non-PC applications or other environments, such as medical, industrial, alarm systems, test equipment, etc. may not be supported without further evaluation by Intel.

Document Organization

The chapters in this Product Guide are arranged as follows:

- 1 Desktop Board Features: a summary of product features
 - 2 Installing and Replacing Desktop Board Components: instructions on how to install the Desktop Board and other hardware components
 - 3 Updating the BIOS: instructions on how to update the BIOS
 - 4 Configuring for RAID (Intel® Matrix Storage Technology (Intel® MST)): information about configuring your system for RAID
 - 5 Configuring for Intel® Rapid Recover Technology (Intel® RRT): information about configuring your system for Intel Rapid Recover Technology
- A Error Messages and Indicators: information about BIOS error messages and beep codes
- B Regulatory Compliance: safety standards, regulations, and product certifications

Conventions

The following conventions are used in this manual:



CAUTION

Cautions warn the user about how to prevent damage to hardware or loss of data.



NOTE

Notes call attention to important information.

Terminology

The table below gives descriptions of some common terms used in the product guide.

Term	Description
GB	Gigabyte (1,073,741,824 bytes)
GHz	Gigahertz (one billion hertz)
KB	Kilobyte (1024 bytes)
MB	Megabyte (1,048,576 bytes)
Mbit	Megabit (1,048,576 bits)
MHz	Megahertz (one million hertz)

Contents

1 Desktop Board Features

Desktop Board Components.....	11
Processor.....	13
Main Memory.....	13
Intel® Q45 Express Chipset	14
Intel Q45 Graphics Subsystem.....	14
DVI Support	15
PCI Express x16 Graphics	15
Audio Subsystem	16
Legacy Input/Output (I/O) Controller	16
LAN Subsystem	17
LAN Subsystem Software.....	17
LAN Status Indicators.....	17
Intel® Active Management Technology (Intel® AMT) 5.0	18
Intel AMT Status Indicator	19
Intel® Virtualization Technology (Intel® VT)	19
Intel® Trusted Execution Technology (Intel® TXT)	20
Hi-Speed USB 2.0 Support	21
Serial ATA.....	21
Serial ATA RAID	21
Intel® Rapid Recover Technology (Intel® RRT)	22
Expandability.....	22
BIOS.....	22
Serial ATA Auto Configuration.....	22
PCI and PCI Express* Auto Configuration	22
Security Passwords.....	23
Intel® Trusted Platform Module (Intel® TPM)	23
Hardware Management Features	24
Fan Speed, Thermal, and Voltage Monitoring and Control	24
Chassis Intrusion.....	24
Power Management Features	25
ACPI.....	25
Hardware Support	25
Power Connectors	25
Fan Headers	25
LAN Wake Capabilities.....	26
Instantly Available PC Technology.....	26
+5 V Standby Power Indicator.....	27
Wake from USB	27
PME# Signal Wake-up Support.....	27
WAKE# Signal Wake-up Support	27
ENERGY STAR* Qualified	28
Speaker.....	28
Battery	28
Real-Time Clock.....	28

2 Installing and Replacing Desktop Board Components

Before You Begin	29
Installation Precautions.....	30
Prevent Power Supply Overload	30
Observe Safety and Regulatory Requirements.....	30
Installing the I/O Shield	31
Installing and Removing the Desktop Board	32
Installing and Removing a Processor	33
Installing a Processor	33
Installing a Processor Fan Heat Sink.....	36
Connecting the Processor Fan Heat Sink Cable.....	37
Removing the Processor	37
Installing and Removing Memory.....	38
Guidelines for Dual Channel Memory Configuration.....	38
Two or Four DIMMs	38
Three DIMMs	39
Installing DIMMs	40
Removing DIMMs.....	42
Installing and Removing a PCI Express x16 Card	43
Installing a PCI Express x16 Card	43
Removing the PCI Express x16 Card.....	44
Connecting Serial ATA (SATA) Cables.....	45
Connecting to Internal Headers.....	46
HD Audio Link Header	47
Front Panel Audio Header	47
Serial Port Header	48
Chassis Intrusion Header	48
Alternate Front Panel Power LED Header	48
Front Panel Header	49
USB 2.0 Headers	49
IEEE 1394a Header.....	50
Connecting to the Audio System.....	50
Connecting Chassis Fan and Power Supply Cables.....	51
Chassis Fan Cables	51
Power Supply Cables.....	52
Setting the BIOS Configuration Jumper	53
Clearing or Changing Passwords.....	54
Replacing the Battery	55

3 Updating the BIOS

Updating the BIOS with the Intel® Express BIOS Update Utility.....	61
Updating the BIOS with the ISO Image BIOS Update File or the Iflash Memory Update Utility.....	62
Obtaining the BIOS Update File	62
Updating the BIOS with the ISO Image BIOS Update File	62
Updating the BIOS with the Iflash Memory Update Utility	63
Recovering the BIOS.....	64

4 Configuring for RAID (Intel® Matrix Storage Technology (Intel® MST))

Configuring the BIOS for Intel Matrix Storage Technology	65
Creating Your RAID Set	65
Loading the Intel Matrix Storage Technology RAID Drivers and Software	66
Setting Up a "RAID Ready" System	66

5 Configuring for Intel® Rapid Recover Technology (Intel® RRT)

Enabling Intel Rapid Recover Technology	67
Creating a Recovery Volume	68
Creating a Recovery Volume Using the RAID Option ROM	68
Creating a Recovery Volume Using the Intel Matrix Storage Console	68
Disk Synchronization Mode	69
Mounting the Recovery Disk	69

A Error Messages and Indicators

BIOS Beep Codes	71
BIOS Error Messages	71

B Regulatory Compliance

Safety Standards	73
Place Battery Marking	73
European Union Declaration of Conformity Statement	74
Product Ecology Statements	75
Recycling Considerations	75
Lead-free 2LI/Pb-free 2LI Board	78
Restriction of Hazardous Substances (RoHS)	79
EU RoHS	79
China RoHS	80
EMC Regulations	82
Ensure Electromagnetic Compatibility (EMC) Compliance	83
Product Certifications	84
Board-Level Certification Markings	84
Chassis and Component Certifications	85

Figures

1. Intel Desktop Board DQ45CB Components	11
2. LAN Status LEDs	17
3. Intel AMT Status Indicator	19
4. Location of the +5 V Standby Power Indicator	27
5. Installing the I/O Shield	31
6. Intel Desktop Board DQ45CB Mounting Screw Hole Locations	32
7. Lift the Socket Lever	33
8. Lift the Load Plate	34
9. Remove the Protective Socket Cover	34
10. Remove the Processor from the Protective Processor Cover	35
11. Install the Processor	35
12. Close the Load Plate	36
13. Connecting the Processor Fan Heat Sink Cable	37
14. Dual Channel Memory Configuration with Two DIMMs	38
15. Dual Channel Memory Configuration with Four DIMMs	39

Intel Desktop Board DQ45CB Product Guide

16. Dual Channel Memory Configuration with Three DIMMs	39
17. Use DDR2 DIMMs	40
18. Installing a DIMM	41
19. Installing a PCI Express x16 Card	43
20. Removing a PCI Express x16 Card.....	44
21. Connecting a Serial ATA Cable.....	45
22. Internal Headers	46
23. Back Panel Audio Connectors.....	50
24. Location of the Chassis Fan Headers.....	51
25. Connecting Power Supply Cables.....	52
26. Location of the BIOS Configuration Jumper Block	53
27. Removing the Battery	60
28. Intel Desktop Board DQ45CB China RoHS Material Self Declaration Table	81

Tables

1. Feature Summary.....	9
2. Intel Desktop Board DQ45CB Components	12
3. Audio Jack Retasking Support	16
4. LAN Connector LEDs	18
5. Intel AMT Status Indicator	19
6. HD Audio Link Header Signal Names	47
7. Front Panel Audio Header Signal Names for HD Audio	47
8. Front Panel Audio Header Signal Names for AC'97 Audio.....	47
9. Serial Port Header Signal Names	48
10. Chassis Intrusion Header Signal Names	48
11. Alternate Front Panel Power LED Header Signal Names	48
12. Front Panel Header Signal Names.....	49
13. USB 2.0 Header Signal Names.....	49
14. IEEE 1394a Header Signal Names	50
15. Jumper Settings for the BIOS Setup Program Modes.....	54
16. Beep Codes	71
17. BIOS Error Messages	71
18. Safety Standards.....	73
19. Lead-Free Second Level Interconnect Marks.....	79
20. China RoHS Environmentally Friendly Use Period Mark	80
21. EMC Regulations.....	82
22. Product Certification Markings	84

1 Desktop Board Features

This chapter briefly describes the features of Intel® Desktop Board DQ45CB. Table 1 summarizes the major features of the Desktop Board.

Table 1. Feature Summary

Form Factor	microATX (243.84 millimeters [9.60 inches] x 243.84 millimeters [9.60 inches])
Processor	Support for an Intel® processor in the LGA775 package
Main Memory	<ul style="list-style-type: none"> • Four 240-pin, DDR2 1.8 V SDRAM Dual Inline Memory Module (DIMM) sockets • 800/667 MHz single or dual channel DDR2 SDRAM interface • Support for up to 8 GB of system memory
Chipset	Intel® Q45 Express Chipset consisting of: <ul style="list-style-type: none"> • Intel 82Q45 Express Chipset Graphics and Memory Controller Hub (GMCH) • Intel® 82801JDO I/O Controller Hub (ICH10DO)
Graphics	<ul style="list-style-type: none"> • Intel Q45 Express Chipset with Intel® Graphics Media Accelerator 4500 (Intel® GMA 4500) • One PCI Express* 2.0 x16 connector supporting PCI Express graphics add-in cards • Integrated graphics output via DVI-D and DVI-I ports
Audio	Onboard subsystem, featuring: <ul style="list-style-type: none"> • Independent 6-channel (5.1) audio streams • 2-channel stereo audio streams via an onboard header • Intel® High Definition Audio (Intel® HD Audio) interface • Analog Devices AD1882 audio codec
Expansion Capabilities	<ul style="list-style-type: none"> • One PCI Express 2.0 x16 connector • Two PCI Express 1.1 x1 connectors • One PCI* connector
Legacy I/O Support	Legacy I/O Controller that provides a serial port via an onboard header
Peripheral Interfaces	<ul style="list-style-type: none"> • Up to 12 USB 2.0 ports: <ul style="list-style-type: none"> — Six ports routed to the back panel — Six ports routed to three USB headers • Up to two IEEE 1394a ports: <ul style="list-style-type: none"> — One port routed to the back panel — One port routed to an onboard IEEE 1394a header • Six Serial ATA (SATA) channels (3.0 Gb/s) via ICH10DO including one external SATA (eSATA) channel • SATA RAID support via Intel® Matrix Storage Technology (Intel® MST) including support for Intel® Rapid Recover Technology (Intel® RRT)

continued

Table 1. Feature Summary (continued)

BIOS	<ul style="list-style-type: none"> • Intel® Platform Innovation Framework for EFI • 32 Mbit symmetrical flash memory device • Support for SMBIOS • Intel® Rapid BIOS Boot • Intel® Express BIOS Update
Power Management	<ul style="list-style-type: none"> • Support for Advanced Configuration and Power Interface (ACPI) • Suspend to RAM (STR) • Wake on USB, PCI Express, PCI, LAN, and front panel • ENERGY STAR* capable
Hardware Management	<p>Hardware monitor with:</p> <ul style="list-style-type: none"> • Three fan sensing inputs used to monitor fan activity • Intel® Quiet System Technology (Intel® QST) fan speed control • Voltage sensing to detect out of range values
LAN Support	<p>Intel® 82567LM Gigabit (10/100/1000 Mb/s) Ethernet LAN controller, including support for:</p> <ul style="list-style-type: none"> • Intel® Active Management Technology (Intel® AMT) 5.0 • ASF 2.0
Intel® Active Management Technology (Intel® AMT)	<p>Intel® AMT provides IT organizations tamper-resistant and persistent management capabilities.</p>
Integrated Intel® Trusted Platform Module (Intel® TPM), revision 1.2	<p>Intel TPM, revision 1.2, enhances platform security.</p>
Operating System Support	<ul style="list-style-type: none"> • Microsoft Windows Vista* Ultimate • Microsoft Windows Vista Enterprise • Microsoft Windows Vista Business • Microsoft Windows Vista Home Premium • Microsoft Windows Vista Home Basic • Microsoft Windows Vista Ultimate 64-bit edition • Microsoft Windows Vista Enterprise 64-bit edition • Microsoft Windows Vista Business 64-bit edition • Microsoft Windows Vista Home Premium 64-bit edition • Microsoft Windows Vista Home Basic 64-bit edition • Microsoft Windows* XP Media Center Edition 2005 • Microsoft Windows XP Professional • Microsoft Windows XP Professional x64 Edition • Microsoft Windows XP Home

For more information about Intel Desktop Board DQ45CB, including the Technical Product Specification (TPS), BIOS updates, and device drivers, go to <http://support.intel.com/support/motherboards/desktop/>.

Desktop Board Components

Figure 1 shows the approximate location of the major components on Intel Desktop Board DQ45CB.

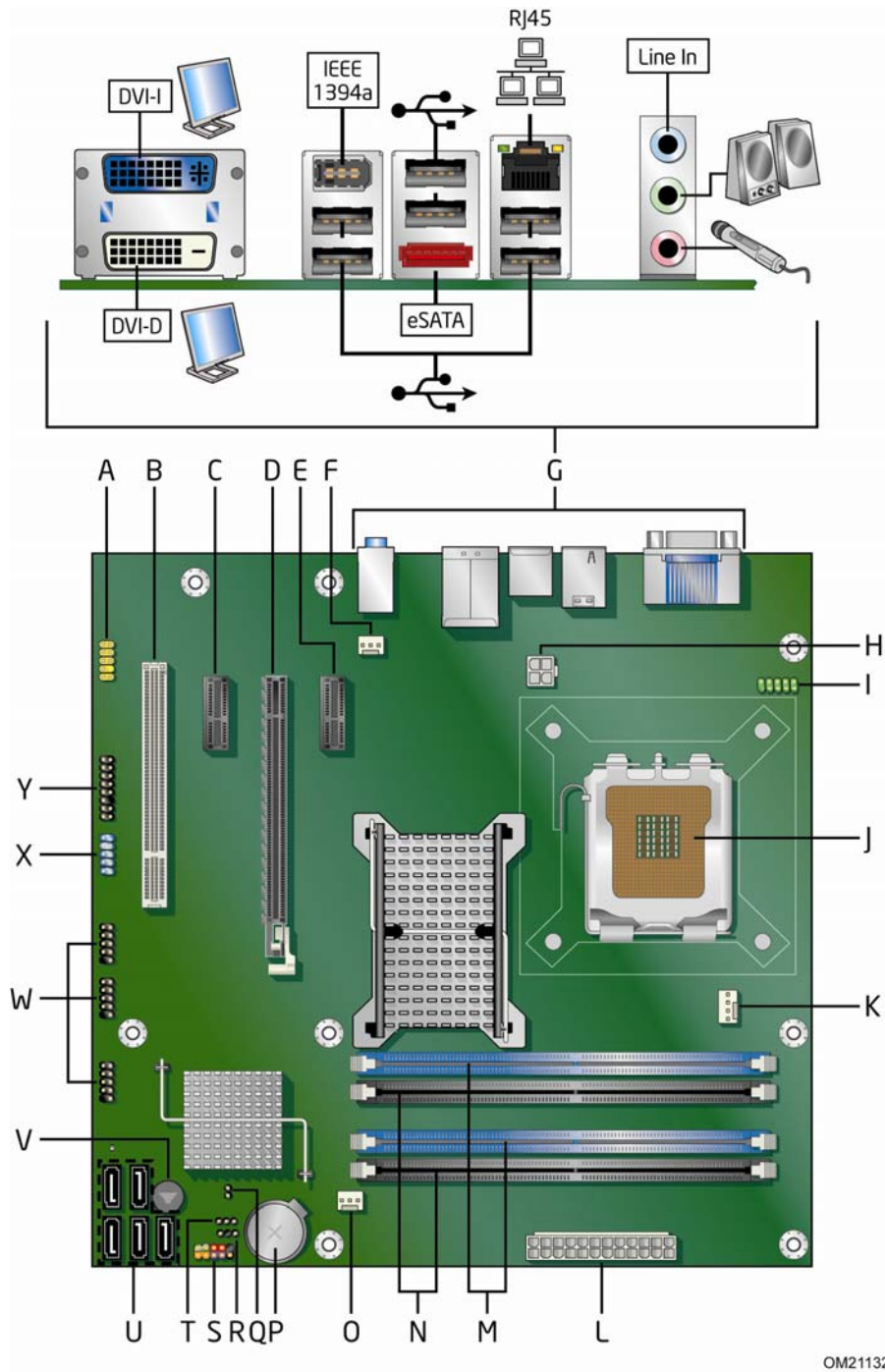

Figure 1. Intel Desktop Board DQ45CB Components

Table 2. Intel Desktop Board DQ45CB Components

Label	Description
A	Front panel audio header
B	PCI bus connector
C	PCI Express x1 connector 2
D	PCI Express x16 connector
E	PCI Express x1 connector 1
F	Rear chassis fan header (3-pin)
G	Back panel connectors
H	12 V processor core voltage connector (2 x 2 pin)
I	Serial header
J	Processor socket
K	Processor fan header (4-pin)
L	Main power connector (2 x 12 pin)
M	DDR2 DIMM 0 sockets
N	DDR2 DIMM 1 sockets
O	Front chassis fan header (3-pin)
P	Battery
Q	Chassis intrusion header
R	Alternate front panel power LED header
S	Front panel header
T	BIOS configuration jumper block
U	Serial ATA connectors (5)
V	Speaker
W	High-speed USB 2.0 headers (3)
X	IEEE 1394a header
Y	HD audio link header

For more information about Intel Desktop Board DQ45CB, go to <http://intel.com/design/motherbd>.

Processor



CAUTION

Failure to use an appropriate power supply and/or not connecting the 12 V (2 x 2 pin) power connector to the Desktop Board may result in damage to the board, or the system may not function properly.

Intel Desktop Board DQ45CB supports an Intel processor in the LGA775 package. Processors are not included with the Desktop Board and must be purchased separately. The processor connects to the Desktop Board through the LGA775 socket.

Go to the following locations for more information about:

- Instructions on installing or upgrading the processor, page 33 in Chapter 2
- Supported processors for Intel Desktop Board DQ45CB, <http://processormatch.intel.com>

Main Memory



NOTE

To be fully compliant with all applicable Intel® SDRAM memory specifications, the board should be populated with DIMMs that support the Serial Presence Detect (SPD) data structure. If your memory modules do not support SPD, you will see a notification to this effect on the screen at power up. The BIOS will attempt to configure the memory controller for normal operation.

The Desktop Board supports the dual or single channel memory configurations defined below.

- Four 240-pin Double Data Rate 2 (DDR2) SDRAM Dual Inline Memory Module (DIMM) connectors with gold-plated contacts
- Support for:
 - Non-ECC, 1.8 V, DDR2 800/667 MHz memory
 - Serial Presence Detect (SPD) memory only
 - Unbuffered, non-registered single- or double-sided DIMMs (except double-sided DIMMs with x16 organization)
 - Memory configurations listed below:
 - Up to 2.0 GB utilizing 256 Mb technology
 - Up to 4.0 GB utilizing 512 Mb or 1 Gb technology
 - Up to 8.0 GB utilizing 1 Gb technology
- A minimum of 512 MB of total memory is required



NOTE

System resources and hardware (such as PCI Express) require physical memory address locations that can reduce available addressable system memory. This could result in a reduction of as much as 1 GB or more of physical addressable memory being available to the operating system and applications, depending on the system configuration and operating system.

Go to the following locations for more information about:

- SDRAM specifications, <http://intel.com/technology/memory/>
- Installing memory, page 38 in Chapter 2
- Tested memory, <http://cmtlabs.com/mbsearch.asp>

Intel® Q45 Express Chipset

The Intel Q45 Express Chipset consists of the following devices:

- Intel 82Q45 Express Chipset Graphics and Memory Controller Hub (GMCH) with Direct Media Interface (DMI)
- Intel 82801JDO I/O Controller Hub (ICH10DO) with DMI

The GMCH component provides interfaces to the processor, memory, PCI Express, and the DMI interconnect. The component also provides integrated graphics capabilities supporting 3D, 2D, and display capabilities. The ICH10DO is a centralized controller for the board's I/O paths.

For more information on the Intel Q45 Express Chipset go to <http://developer.intel.com/products/chipsets/>

Intel Q45 Graphics Subsystem

The Intel Q45 Express Chipset provides DVI-D and DVI-I support via the integrated Intel Graphics Media Accelerator 4500 (GMA 4500) graphics controller.

The Intel GMA 4500 graphics controller has the following features:

- Advanced graphics performance, including:
 - DirectX10.0* and OpenGL* 2.0 compliant
 - Shader Model 4.0 support
- Enhanced video playback support, including:
 - Support for playback of Blu-ray Disc* technology DVDs
 - Microsoft Windows Vista* only
 - Hardware acceleration supported for MPEG-2 only
 - Software DVD at 30 fps full screen
 - Dynamic Video Memory Technology (DVMT) 5.0

- Advanced display support, including:
 - DVI specification 1.0 compliant
 - Dual independent display support via the DVI-I and DVI-D back panel connectors
 - High Definition Content Protection (HDCP) version 1.1 support
 - DDC2B compliant interface with Advanced Digital Display 2 card or Media Expansion Card (ADD2/MEC), support for TV-out/TV-in and DVI digital display connections
 - Support for all HD display resolutions including 720p, 1080i, and 1080p
 - Support for digital and analog displays up to 2048 x 1536 at 75 Hz refresh rate (QXGA); also supports 1920 x 1080 resolution for full High Definition video playback quality

DVI Support

The DVI-I port supports both digital and analog DVI displays while the DVI-D port supports digital DVI displays only. The maximum supported resolution is 2048 x 1536 at 75 Hz refresh rate (QXGA). DVI analog output can be converted to VGA with a DVI-to-VGA connector.

When a PCI Express x16, x8, or x4 add-in card is installed on the Desktop Board, the digital portion of the DVI-I port and the DVI-D port are disabled.

PCI Express x16 Graphics

The GMCH supports an add-in PCI Express discrete graphics card via the PCI Express 2.0 x16 connector as follows:

- Supports PCI Express 1.1 frequency of 1.25 GHz resulting in 2.5 Gb/s each direction (500 MB/s total). The maximum theoretical bandwidth on the interface is 4 GB/s in each direction simultaneously, for an aggregate of 8 GB/s when operating in x16 mode.
- Supports PCI Express 2.0 frequency of 2.5 GHz resulting in 5.0 Gb/s each direction (1000 MB/s total). The maximum theoretical bandwidth on the interface is 8 GB/s in each direction simultaneously, for an aggregate of 16 GB/s when operating in x16 mode.

For more information on PCI Express technology, go to <http://pcisig.com>.

Audio Subsystem

The onboard audio subsystem consists of the following:

- Intel ICH10DO I/O controller hub
- Analog Devices AD1882 audio codec
- Intel High Definition Audio front panel audio header
- Intel High Definition Audio Link header
- Back panel audio connectors

The audio subsystem supports the following features:

- A signal-to-noise (S/N) ratio of 95 dB
- Independent multi-streaming 6-channel (5.1) audio (using the back panel audio connectors) and stereo (using the front panel Intel High Definition Audio header)

Go to the following locations for more information about:

- Audio drivers and utilities <http://support.intel.com/support/motherboards/desktop/>
- Location of the onboard audio headers, Figure 22 on page 46

Figure 23 on page 50 shows the location of the back panel audio connectors.

Table 3 lists the supported functions for the front panel and back panel audio jacks.

Table 3. Audio Jack Retasking Support

Jack	Mic	Line out	Headphones	Line in	Rear Surround	Center/ Subwoofer
Front Panel						
Green	No	Yes	Yes	No	No	No
Pink	Yes	No	No	No	No	No
Back Panel						
Blue	No	No	No	Yes	Yes	No
Green	No	Yes	Yes	No	No	No
Pink	Yes	No	No	No	No	Yes

Legacy Input/Output (I/O) Controller

The I/O controller features the following:

- Low pin count (LPC) interface
- One serial port interface via an onboard header
- Serial IRQ interface compatible with serialized IRQ support for PCI systems
- Intelligent power management, including a programmable wake up event interface
- PCI power management support

LAN Subsystem

The LAN subsystem includes:

- Intel® ICH10DO
- Intel 82567LM Gigabit (10/100/1000 Mb/s) Ethernet LAN controller with support for:
 - Intel AMT 5.0
 - Alert Standard Format (ASF) 2.0
 - Virtual LAN driver support for Intel® Virtualization Technology (Intel® VT) partitions
- RJ-45 LAN connector with integrated status LEDs

The subsystem features:

- CSMA/CD protocol engine
- LAN connect interface between ICH10DO and the LAN controller
- PCI Express power management

For information about LAN software and drivers go to

<http://support.intel.com/support/motherboards/desktop>

LAN Subsystem Software

For LAN software and drivers, refer to the Intel Desktop Board DQ45CB link on Intel's World Wide Web site at <http://support.intel.com/support/motherboards/desktop>.

LAN Status Indicators

Two LEDs are built into the RJ-45 LAN connector located on the back panel (see Figure 2). These LEDs indicate the operating states of the LAN.

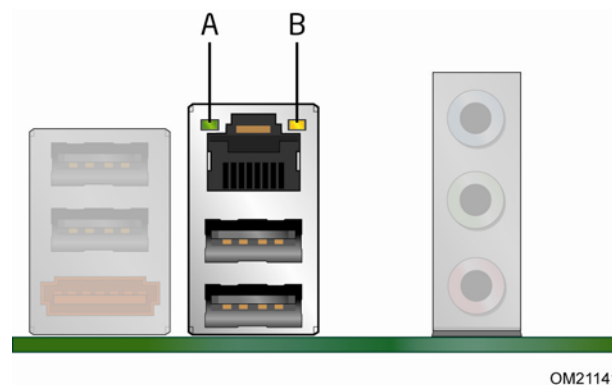

Figure 2. LAN Status LEDs

Table 4 describes the LED states when the board is powered up and the LAN subsystem is operating.

Table 4. LAN Connector LEDs

LED	LED Color	LED State	Indicates
A (Link)	Green	Off	LAN link is not established
		On	LAN link is established
		Blinking	LAN activity is occurring
B (Speed)	N/A	Off	10 Mb/s data rate
	Green	On	100 Mb/s data rate
	Yellow	On	1000 Mb/s data rate

Intel® Active Management Technology (Intel® AMT) 5.0

Intel AMT 5.0 offers IT organizations tamper-resistant and persistent management capabilities. Intel AMT is a hardware-based solution that uses out of band communication to manage access to client systems in addition to offering encrypted and persistent asset management and remote diagnostics and/or recovery capabilities for networked platforms. With Intel AMT, IT organizations can easily get accurate platform information, and can perform remote updating, diagnostics, debugging and repair of a system, regardless of the state of the operating system or the power state of the system.

The Intel AMT subsystem consists of:

- ARC4 microcontroller embedded in the Intel 82Q45 GMCH
- ICH10DO (Intel® Management Engine function)
- Intel 82567LM Gigabit (10/100/1000 Mb/s) Ethernet LAN controller
- Channel A DIMM(s)
- BIOS/SPI Flash
- On-board Intel AMT status indicator



NOTE

Software with Intel AMT capability is required to take advantage of the Intel AMT platform management capabilities.

Intel AMT Status Indicator

The Intel AMT status indicator (red LED) shows the current state of the Intel Management Engine. Table 5 shows the states of the Intel Management Engine as indicated by the LED. Figure 3 shows the location of the Intel AMT status indicator.

Table 5. Intel AMT Status Indicator

LED State	Indicates
Off	Intel Management Engine is in the off state
On	Intel Management Engine is in the on state and fully functional
Blinking	Intel Management Engine is in the M1 state; system is out of band; Intel Management Engine is functional

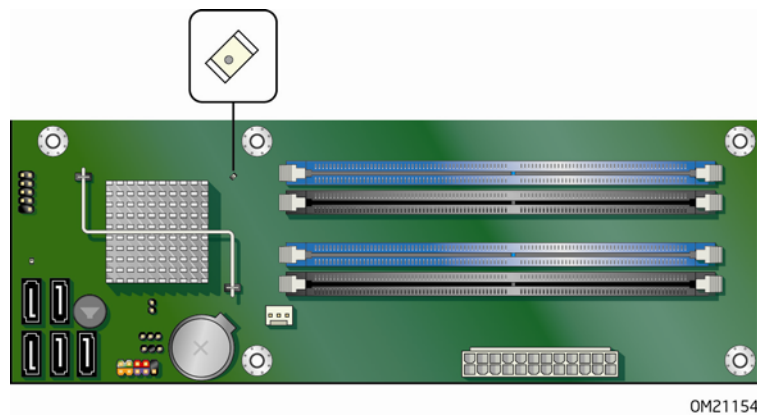

Figure 3. Intel AMT Status Indicator

Intel® Virtualization Technology (Intel® VT)

Intel® Virtualization Technology (Intel® VT) consists of components that support virtualization of platforms based on Intel processors, thereby enabling the running of multiple operating systems and applications in independent partitions. Each partition behaves like a virtual machine (VM) and provides isolation and protection across partitions. This hardware-based virtualization solution, along with virtualization software, enables multiple usages such as server consolidation, activity partitioning, workload isolation, embedded management, legacy software migration, and disaster recovery.

- Intel Virtualization Technology (Intel VT)
Hardware support for processor virtualization enables simple, robust and reliable VMM software. VMM software relies on hardware support on operational details for the handling of events, exceptions, and resources allocated to virtual machines.

- Intel Virtualization Technology (Intel® VT) for Directed I/O (Intel® VT-d)
Intel VT-d provides additional performance, security and flexibility by providing the VMM with the following capabilities:
 - I/O device assignment: for flexibly assigning I/O devices to VMs and extending the protection and isolation properties of VMs for I/O operations.
 - DMA remapping: for supporting independent address translations for Direct Memory Accesses (DMA) from devices.
 - Interrupt remapping: for supporting isolation and routing of interrupts from devices and external interrupt controllers to appropriate VMs.
 - Reliability: for recording and reporting to system software DMA and interrupt errors that may otherwise corrupt memory or impact VM isolation.



NOTE

Intel VT requires the use of a processor with Intel VT support. Additionally, a third-party VMM may also be required.

Intel® Trusted Execution Technology (Intel® TXT)

Intel® Trusted Execution Technology (Intel® TXT) is a highly versatile set of hardware extensions to Intel® processors and chipsets that, with appropriate software, enhance the platform security capabilities. Intel TXT will provide a hardware-based security foundation that will help enable greater levels of protection for information stored, processed and exchanged on the PC.

Intel Trusted Execution Technology capabilities include:

- Protected execution and memory spaces where sensitive data can be processed out of view of any other software.
- Sealed storage shields encryption keys and other data from attack while in use or stored.
- Attestation enables a system to provide assurance that it has correctly invoked the Intel Trusted Execution Technology environment, as well as enable a verified measurement of the software running in the protected space.
- Measured launch capability to help:
 - Reduce IT support costs with improved services
 - Enable decentralized or remote computing
 - Verify platform configuration with a higher level of assurance
- Memory protection to help:
 - Enhance protection of system resources
 - Increase confidentiality and integrity of data
 - Improve assurance of data transfers and resources
 - Improve protection of sensitive information

These Intel Trusted Execution Technology capabilities enable more secure platforms to address the increasing frequency and sophistication of software-based attacks.

**NOTE**

Intel TXT requires the use of a processor with Intel TXT support. Additionally, third-party software may also be required.

Hi-Speed USB 2.0 Support

The Desktop Board supports up to 12 USB 2.0 ports (six ports routed to the back panel and six ports routed to three internal headers) via ICH10DO. USB 2.0 ports are backward compatible with USB 1.1 devices. USB 1.1 devices will function normally at USB 1.1 speeds.

USB 2.0 support requires both an operating system and drivers that fully support USB 2.0 transfer rates. Disabling Hi-Speed USB in the BIOS reverts all USB 2.0 ports to USB 1.1 operation. This may be required to accommodate operating systems that do not support USB 2.0.

Serial ATA

The Desktop Board supports six Serial ATA channels (3.0 Gb/s) via ICH10DO, connecting one device per channel. One channel is configured as an eSATA channel.

Serial ATA RAID

ICH10DO supports Intel® Matrix Storage Technology which enables the following RAID (Redundant Array of Independent Drives) levels:

- RAID 0 - data striping
- RAID 1 - data mirroring
- RAID 0+1 (or RAID 10) - data striping and mirroring
- RAID 5 - distributed parity

For information on configuring your system for RAID using Intel Matrix Storage Technology see Chapter 4.

Intel® Rapid Recover Technology (Intel® RRT)

The Desktop Board supports Intel Rapid Recover Technology which enables fast and easy recovery of your data in the event of a hard drive failure. It allows you to maintain a complete copy of your primary or master drive onto a second hard drive, the recovery drive. If the master hard drive should fail, either from a mechanical failure or the result of a virus, recovery is as simple as booting from the recovery drive. The recovery drive can be attached to your system via any standard SATA or eSATA connection.

Intel Rapid Recover Technology also provides the added benefit of allowing the recovery drive to be mounted as a read-only volume so you can quickly copy files from the recovery drive when individual files need to be recovered.

For information on configuring your system for Intel Rapid Recover Technology see Chapter 5.

Expandability

For system expansion, the Desktop Board provides the following expansion slots:

- One PCI Express 2.0 x16 connector (compatible with PCI Express 1.1 add-in cards)
- Two PCI Express 1.1 x1 connectors
- One PCI bus connector

BIOS

The BIOS provides the Power-On Self-Test (POST), the BIOS Setup program, the PCI/PCI Express auto-configuration utilities, and the video BIOS. The BIOS is stored in the Serial Peripheral Interface (SPI) Flash device.

The BIOS can be updated by following the instructions in Chapter 3.

Serial ATA Auto Configuration

If you install a Serial ATA device (such as a hard drive) in your computer, the auto-configuration utility in the BIOS automatically detects and configures the device for your computer. You do not need to run the BIOS Setup program after installing a Serial ATA device. You can override the auto-configuration options by specifying manual configuration in the BIOS Setup program.

PCI and PCI Express* Auto Configuration

If you install a PCI/PCI Express add-in card in your computer, the PCI/PCI Express auto-configuration utility in the BIOS automatically detects and configures the resources (IRQs, DMA channels, and I/O space) for that add-in card. You do not need to run the BIOS Setup program after you install a PCI/PCI Express add-in card.

Security Passwords

The BIOS includes security features that restrict whether the BIOS Setup program can be accessed and who can boot the computer. A supervisor password and a user password can be set for the BIOS Setup and for booting the computer, with the following restrictions:

- The supervisor password gives unrestricted access to view and change all Setup options. If only the supervisor password is set, pressing <Enter> at the password prompt of Setup gives the user restricted access to Setup.
- If both the supervisor and user passwords are set, you must enter either the supervisor password or the user password to access Setup. Setup options are then available for viewing and changing depending on whether the supervisor or user password was entered.
- Setting a user password restricts who can boot the computer. The password prompt is displayed before the computer is booted. If only the supervisor password is set, the computer boots without asking for a password. If both passwords are set, you can enter either password to boot the computer.

For instructions on resetting the password, see “Clearing or Changing Passwords” on page 54.

Intel® Trusted Platform Module (Intel® TPM)

The Intel® Trusted Platform Module (Intel® TPM) component is designed to enhance platform security above and beyond the capabilities of today’s software by providing a protected space for key operations and other security critical tasks. Using both hardware and software, the TPM protects encryption and signature keys at their most vulnerable stages—operations when the keys are being used unencrypted in plain-text form. The TPM is specifically designed to shield unencrypted keys and platform authentication information from software-based attacks.



NOTE

The Intel TPM uses the onboard coin-cell battery (CR2032) to maintain its monotonic counters. One major function of the monotonic counters is for anti-replay protection of the internal Intel TPM data. If the battery is removed or exhausted, the Intel TPM data will be deleted in accordance with Trusted Computing Group guidelines. Please read the Intel TPM user guide and back-up Intel TPM keys and data before removing the battery.

Hardware Management Features

The hardware management features of Intel Desktop Board DQ45CB enable the board to be compatible with the Wired for Management (WfM) specification. The board has several hardware management features including the following:

- Fan speed monitoring and control
- Thermal and voltage monitoring
- Chassis intrusion detection

Fan Speed, Thermal, and Voltage Monitoring and Control

The board's fan speed, thermal, and voltage monitoring and control features include the following:

- Monitoring of power supply voltages to detect levels above and below acceptable values
- Intel Quiet System Technology fan speed control, delivering acoustically-optimized thermal management



NOTE

Memory must be installed in the Channel A, DIMM 0 socket to enable Intel Quiet System Technology.

- Thermally monitored closed-loop fan control, for all onboard fans, that can adjust fan speed according to thermal conditions.
- Fan speed controllers and sensors integrated into the ICH10DO
- Thermal sensors in the processor, GMCH, and ICH10DO, plus an onboard remote sensor



NOTE

The minimum thermal reporting threshold for the GMCH is 66 °C. The GMCH thermal sensor will display 66 °C until the temperature rises above this point.

Chassis Intrusion

The board supports a chassis security feature that detects if the chassis cover has been removed. The security feature uses a mechanical switch on the chassis that can be connected to the chassis intrusion header on the Desktop Board. See Figure 22 for the location of the chassis intrusion header.

Power Management Features

Power management is implemented at several levels, including:

- Software support through the Advanced Configuration and Power Interface (ACPI)
- Hardware support:
 - Power connectors
 - Fan headers
 - LAN wake capabilities
 - Instantly Available PC technology (Suspend to RAM)
 - +5 V standby power indicator LED
 - Wake from USB
 - Power Management Event signal (PME#) wakeup support
 - WAKE# signal wake-up support
- ENERGY STAR qualified

ACPI

ACPI gives the operating system direct control over the power management and Plug and Play functions of a computer. The use of ACPI with the Desktop Board requires an operating system that provides full ACPI support.

Hardware Support

Power Connectors

ATX12V-compliant power supplies can turn off the computer power through system control. When an ACPI-enabled computer receives the correct command, the power supply removes all non-standby voltages.

When resuming from an AC power failure, the computer returns to the power state it was in before power was interrupted (either on or off). The computer's response can be set by using the Last Power State feature in the BIOS Setup program's Boot menu.

The Desktop Board has two power connectors. See Figure 25 on page 52 for the location of the power connectors.

Fan Headers

The function/operation of the fans is as follows:

- The fans are on when the computer is in the ACPI S0 state.
- The fans are off when the computer is in the ACPI S3, S4, or S5 state.
- All fan headers support closed-loop fan control that can adjust the fan speed according to thermal conditions.
- All fan headers have a +12 V DC connection.

The Desktop Board has a 4-pin processor fan header and two 3-pin chassis fan headers.

LAN Wake Capabilities



CAUTION

For LAN wake capabilities, the 5 V standby line for the power supply must be capable of delivering adequate +5 V standby current. Failure to provide adequate standby current when using this feature can damage the power supply.

LAN wakeup capabilities enable remote wake-up of the computer through a network. The LAN subsystem monitors network traffic and upon detecting a Magic Packet* frame, it asserts a wake-up signal that powers up the computer.

Instantly Available PC Technology



CAUTIONS

For Instantly Available PC technology, the 5 V standby line for the power supply must be capable of delivering adequate +5 V standby current. Failure to provide adequate standby current when using this feature can damage the power supply and/or effect ACPI S3 sleep state functionality.

Power supplies used with this Desktop Board must be able to provide enough standby current to support the standard Instantly Available (ACPI S3 sleep state) configuration. If the standby current necessary to support multiple wake events from the PCI and/or USB buses exceeds power supply capacity, the Desktop Board may lose register settings stored in memory.

Instantly Available PC technology enables the board to enter the ACPI S3 (Suspend-to-RAM) sleep state. While in the S3 sleep state, the computer will appear to be off. If the computer has a dual-colored power LED on the front panel, the sleep state is indicated by the LED turning amber. When signaled by a wake-up device or event, the computer quickly returns to its last known awake state.

The Desktop Board supports the *PCI Bus Power Management Interface Specification*. Add-in cards that support this specification can participate in power management and can be used to wake the computer.

+5 V Standby Power Indicator



CAUTION

If the AC power has been switched off and the standby power indicator is still lit, disconnect the power cord before installing or removing any devices connected to the board. Failure to do so could damage the board and any attached devices.

The Desktop Board's standby power indicator, shown in Figure 4, is lit when there is standby power still present on the board even when the computer appears to be off. For example, when this green LED is lit, standby power is still present at the memory module sockets and the PCI/PCI Express bus connectors.

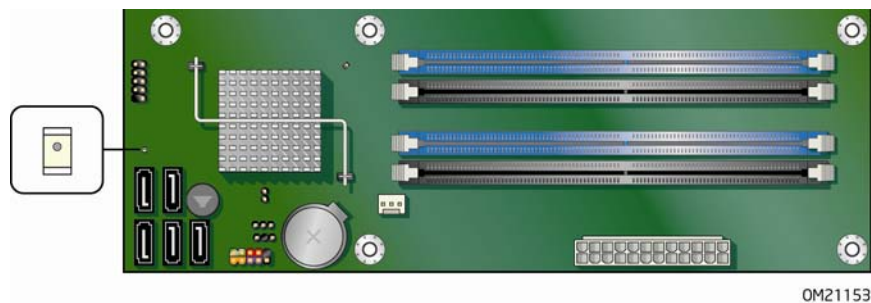

Figure 4. Location of the +5 V Standby Power Indicator

For more information on standby current requirements for the Desktop Board, refer to the Technical Product Specification by going to <http://support.intel.com/support/motherboards/desktop/>, finding the product, and clicking on the Technical Documents tab.

Wake from USB



NOTE

Wake from USB requires the use of a USB peripheral that supports Wake from USB.

USB bus activity wakes the computer from an ACPI S3 state.

PME# Signal Wake-up Support

When the PME# signal on the PCI bus is asserted, the computer wakes from an ACPI S3, S4, or S5 state.

WAKE# Signal Wake-up Support

When the WAKE# signal on the PCI Express bus is asserted, the computer wakes from an ACPI S1, S3, S4, or S5 state.

ENERGY STAR* Qualified

In 2007, the US Department of Energy and the US Environmental Protection Agency revised the ENERGY STAR requirements. Intel worked directly with these two governmental agencies to define the new requirements. This Desktop Board meets the ENERGY STAR Category A requirements.

For information about the ENERGY STAR specifications, see:
<http://intel.com/cd/channel/reseller/asm-na/eng/337748.htm>.

Speaker

A speaker is mounted on the Desktop Board. The speaker provides audible error code (beep code) information during the Power-On Self-Test (POST).

Battery

A battery on the Desktop Board keeps the values in CMOS RAM and the clock current when the computer is turned off. Go to page 55 for instructions on how to replace the battery.

Real-Time Clock

The Desktop Board has a time-of-day clock and 100-year calendar. The battery on the Desktop Board keeps the clock current when the computer is turned off.

2 Installing and Replacing Desktop Board Components

This chapter tells you how to:

- Install the I/O shield
- Install and remove the Desktop Board
- Install and remove a processor
- Install and remove memory
- Install and remove a PCI Express x16 card
- Connect the Serial ATA cables
- Connect to the internal headers
- Connect to the onboard audio system
- Connect chassis fan and power supply cables
- Set the BIOS configuration jumper
- Clear passwords
- Replace the battery

Before You Begin



CAUTIONS

The procedures in this chapter assume familiarity with the general terminology associated with personal computers and with the safety practices and regulatory compliance required for using and modifying electronic equipment.

Disconnect the computer from its power source and from any telecommunications links, networks, or modems before performing any of the procedures described in this chapter. Failure to disconnect power, telecommunications links, networks, or modems before you open the computer or perform any procedures can result in personal injury or equipment damage. Some circuitry on the board can continue to operate even though the front panel power button is off.

Follow these guidelines before you begin:

- Always follow the steps in each procedure in the correct order.
- Set up a log to record information about your computer, such as model, serial numbers, installed options, and configuration information.
- Electrostatic discharge (ESD) can damage components. Perform the procedures described in this chapter only at an ESD workstation using an antistatic wrist strap and a conductive foam pad. If such a station is not available, you can provide some ESD protection by wearing an antistatic wrist strap and attaching it to a metal part of the computer chassis.

Installation Precautions

When you install and test the Intel Desktop Board, observe all warnings and cautions in the installation instructions.

To avoid injury, be careful of:

- Sharp pins on connectors
- Sharp pins on printed circuit assemblies
- Rough edges and sharp corners on the chassis
- Hot components (such as processors, voltage regulators, and heat sinks)
- Damage to wires that could cause a short circuit

Observe all warnings and cautions that instruct you to refer computer servicing to qualified technical personnel.

Prevent Power Supply Overload

Do not overload the power supply output. To avoid overloading the power supply, make sure that the calculated total current loads of all the modules within the computer is less than the output current rating of each of the power supplies output circuits.

Observe Safety and Regulatory Requirements

Read and adhere the instructions in this section and the instructions supplied with the chassis and associated modules. If you do not follow these instructions and the instructions provided by the chassis and module suppliers, you increase safety risk and the possibility of noncompliance with regional laws and regulations. If the instructions for the chassis are inconsistent with these instructions or the instructions for associated modules, contact the supplier's technical support to find out how you can ensure that your computer meets safety and regulatory requirements.

For information about regulatory compliance, go to Appendix B on page 73.

Installing the I/O Shield

The Desktop Board comes with an I/O shield. When installed in the chassis, the shield blocks radio frequency transmissions, protects internal components from dust and foreign objects, and promotes correct airflow within the chassis.

Install the I/O shield before installing the Desktop Board in the chassis. Place the shield inside the chassis as shown in Figure 5. Press the shield into place so that it fits tightly and securely. If the shield does not fit, obtain a properly sized shield from the chassis supplier.

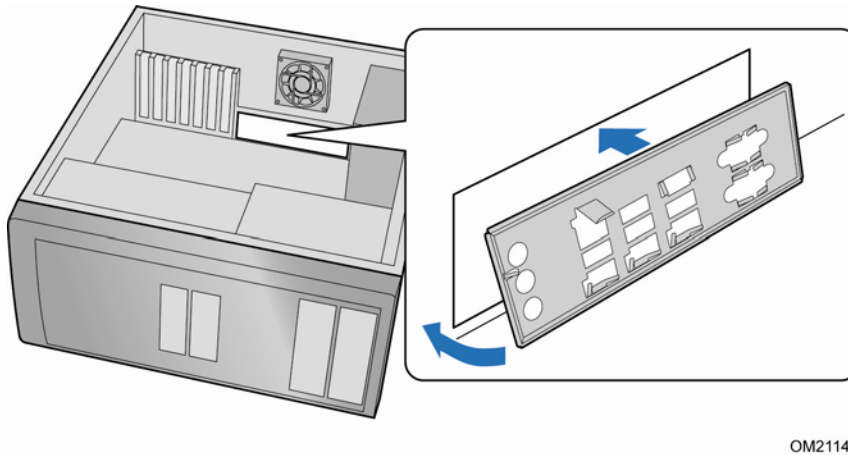

OM21142

Figure 5. Installing the I/O Shield

Installing and Removing the Desktop Board



CAUTION

Only qualified technical personnel should do this procedure. Disconnect the computer from its power source before performing the procedures described here. Failure to disconnect the power before you open the computer can result in personal injury or equipment damage.

Refer to your chassis manual for instructions on installing and removing the Desktop Board.

Figure 6 shows the location of the mounting screw holes for Intel Desktop Board DQ45CB.

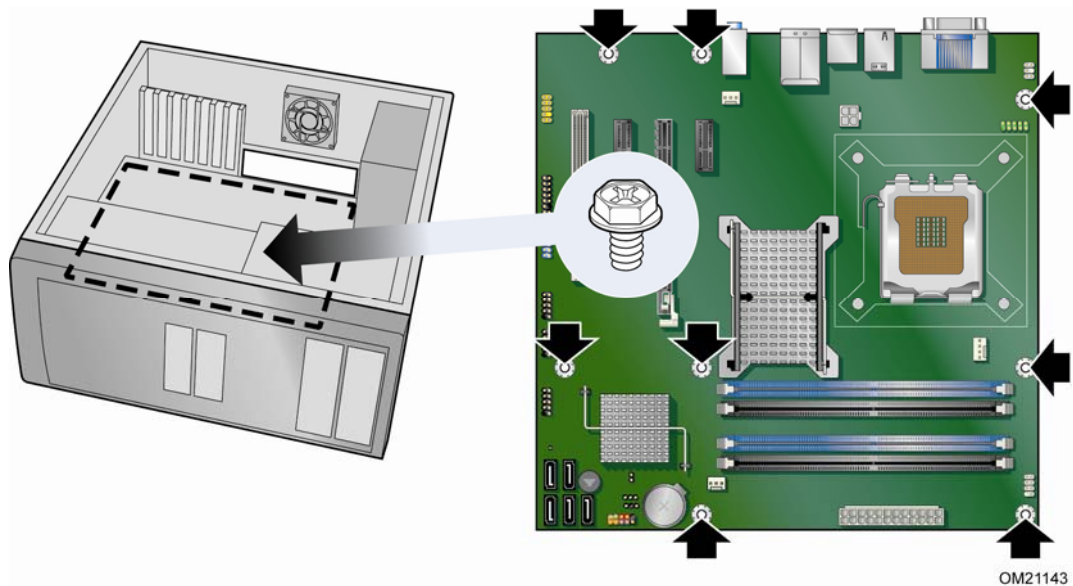

Figure 6. Intel Desktop Board DQ45CB Mounting Screw Hole Locations

Installing and Removing a Processor

This section contains information on how to install and remove a processor on the Desktop Board.

Installing a Processor



CAUTION

Before installing or removing the processor, make sure the AC power has been removed by unplugging the power cord from the computer; the standby power LED should not be lit (see Figure 4 on page 27). Failure to do so could damage the processor and the board.

To install a processor, follow these instructions:

1. Observe the precautions in "Before You Begin" on page 29.
2. Open the socket lever by pushing the lever down and away from the socket (Figure 7, A and B).

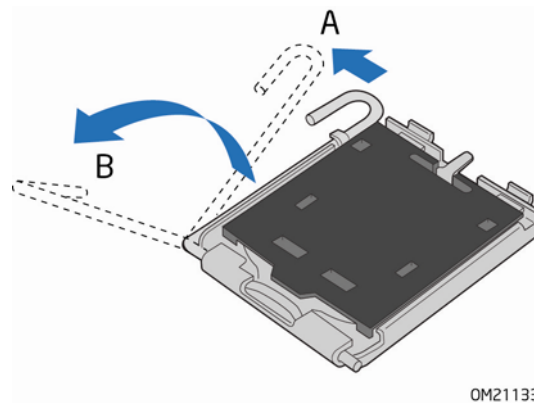

Figure 7. Lift the Socket Lever

3. Lift the load plate (Figure 8, A). Do not touch the socket contacts (Figure 8, B).

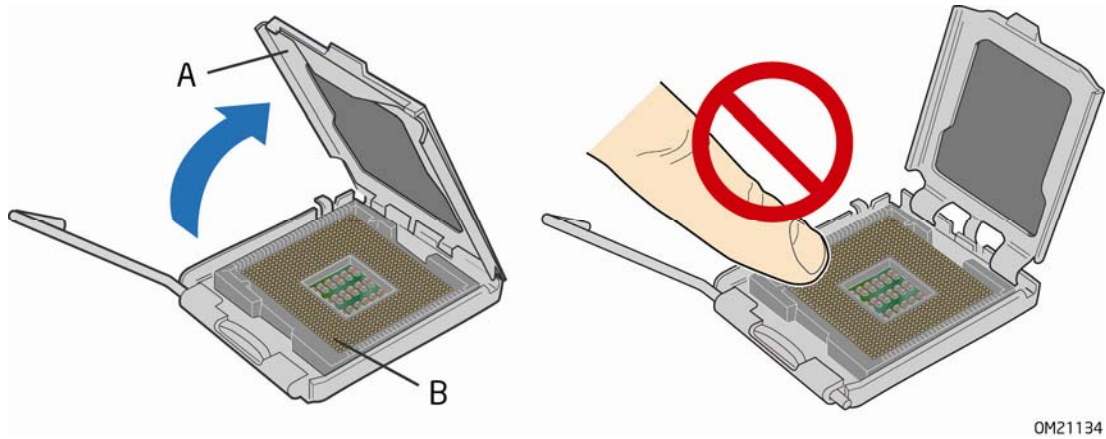

Figure 8. Lift the Load Plate

4. Remove the plastic protective socket cover from the load plate (Figure 9). Do not discard the protective socket cover. Always replace the socket cover if the processor is removed from the socket.

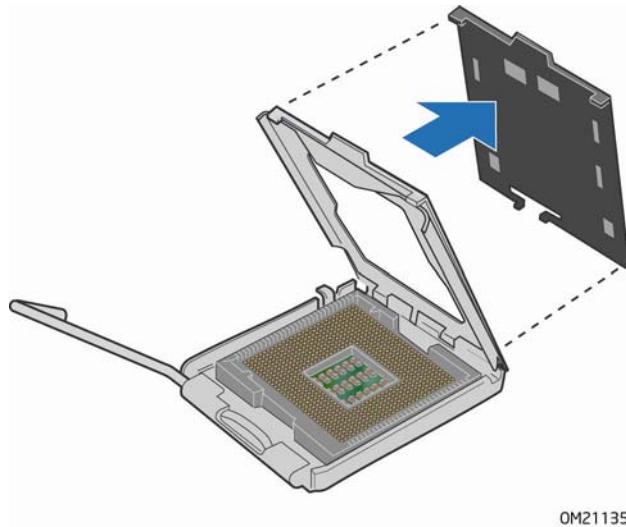

Figure 9. Remove the Protective Socket Cover

5. Remove the processor from the protective processor cover. Hold the processor only at the edges, being careful not to touch the bottom of the processor (see Figure 10). Do not discard the protective processor cover. Always replace the processor cover if the processor is removed from the socket.



OM21136

Figure 10. Remove the Processor from the Protective Processor Cover

6. Hold the processor with your thumb and index fingers oriented as shown in Figure 11. Make sure your fingers align to the socket cutouts (Figure 11, A). Align notches (Figure 11, B) with the socket (Figure 11, C). Lower the processor straight down without tilting or sliding it in the socket.

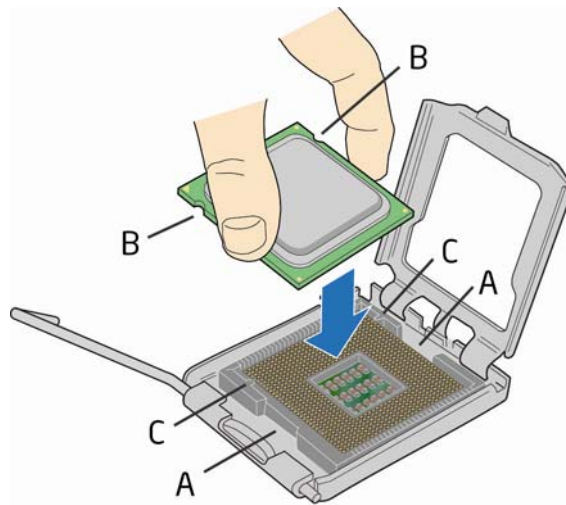

OM21137

Figure 11. Install the Processor

7. Pressing down on the load plate (Figure 12, A), close and engage the socket lever (Figure 12, B).

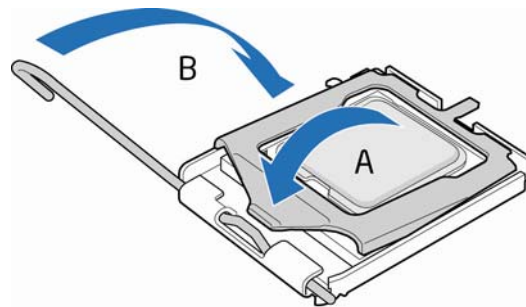

OM21138

Figure 12. Close the Load Plate

Installing a Processor Fan Heat Sink

Intel Desktop Board DQ45CB has mounting holes for a processor fan heat sink. For instructions on how to attach the processor fan heat sink to the Desktop Board, refer to the boxed processor manual.

Connecting the Processor Fan Heat Sink Cable

Connect the processor fan heat sink cable to the 4-pin processor fan header (see Figure 13). A fan with a 4-pin connector as shown in Figure 13, A is recommended; however, a fan with a 3-pin connector (Figure 13, B) can be used. However, since a fan with a 3-pin connector cannot use the onboard fan control, the fan will always operate at full speed.

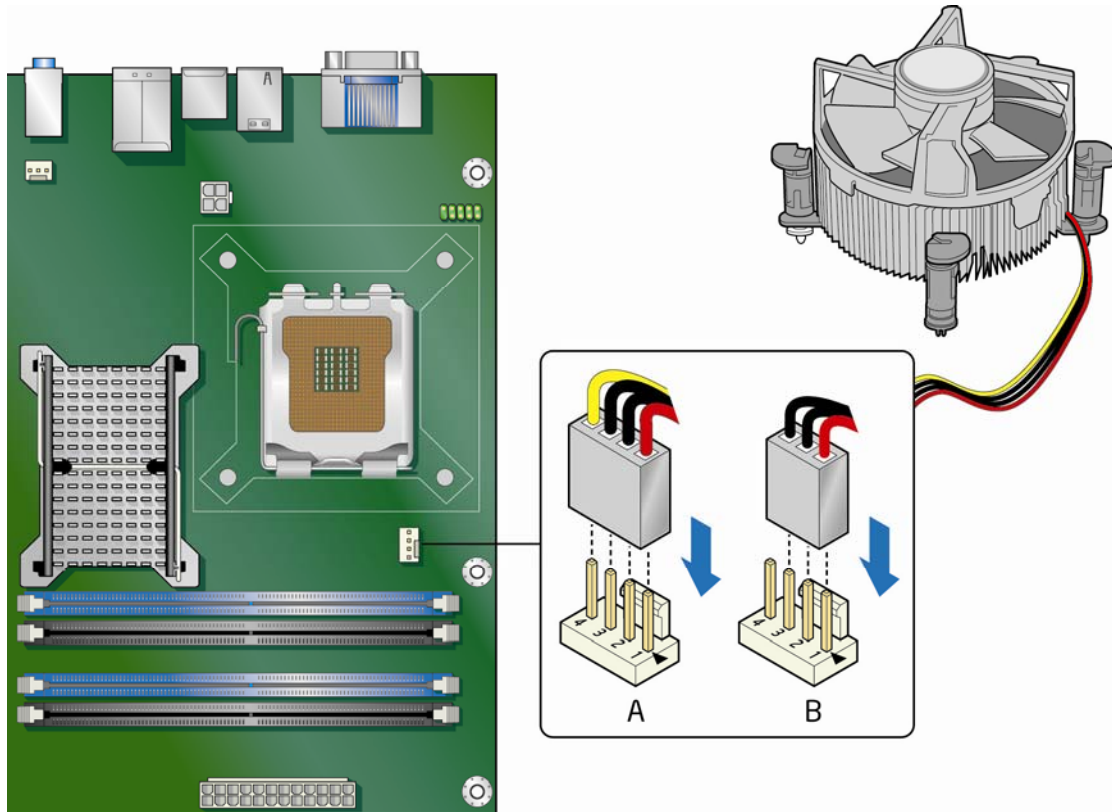

OM21155

Figure 13. Connecting the Processor Fan Heat Sink Cable

Removing the Processor

For instructions on how to remove the processor fan heat sink and processor, refer to the processor installation manual.

Installing and Removing Memory

Intel Desktop Board DQ45CB has four 240-pin DDR2 DIMM sockets arranged as DIMM 0 and DIMM 1 in both Channel A and Channel B.



NOTE

Regardless of the memory configuration used (dual or single channel), Channel A, DIMM 0 must always be populated. This is a requirement of the ICH10DO Manageability Engine feature.

Guidelines for Dual Channel Memory Configuration

Before installing DIMMs, read and follow these guidelines for dual channel configuration.

Two or Four DIMMs

Install a matched pair of DIMMs equal in speed and size (see Figure 14) in DIMM 0 (blue) of channels A and B.

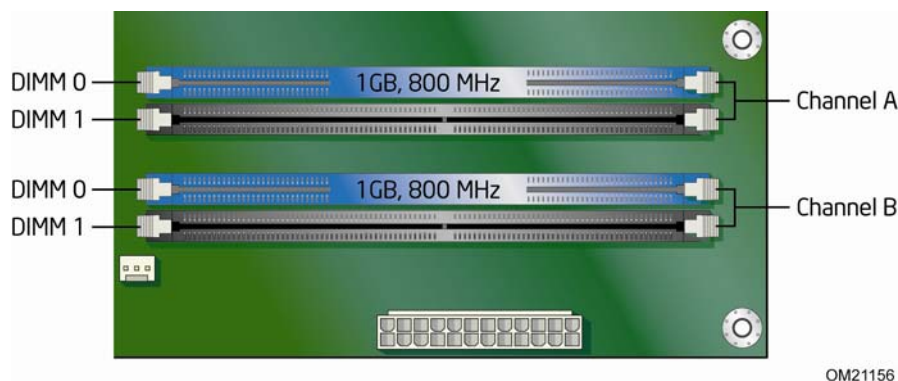

Figure 14. Dual Channel Memory Configuration with Two DIMMs

If additional memory is to be used, install another matched pair of DIMMs in DIMM 1 (black) in channels A and B (see Figure 15).



Figure 15. Dual Channel Memory Configuration with Four DIMMs

Three DIMMs

If you want to use three DIMMs in a dual-channel configuration, install a matched pair of DIMMs equal in speed and size in DIMM 0 (blue) and DIMM 1 (black) of channel A. Install a DIMM equal in speed and total size of the DIMMs installed in channel A in either DIMM 0 or DIMM 1 of channel B (see Figure 16).



Figure 16. Dual Channel Memory Configuration with Three DIMMs



NOTE

All other memory configurations will result in single channel memory operation.

Installing DIMMs

To make sure you have the correct DIMM, place it on the illustration of the DDR2 DIMM in Figure 17. All the notches should match with the DDR2 DIMM.

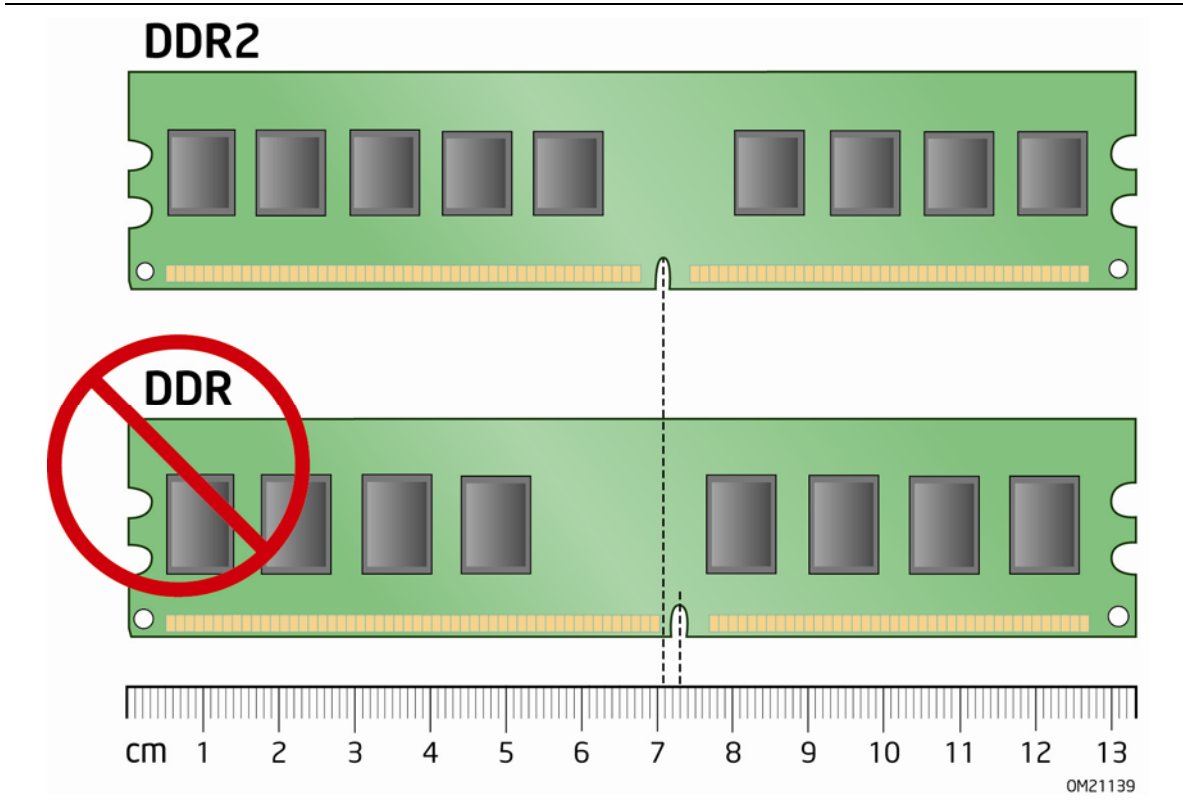

Figure 17. Use DDR2 DIMMs

To install a DIMM, follow these steps:

1. Observe the precautions in "Before You Begin" on page 29.
2. Turn off all peripheral devices connected to the computer. Turn off the computer and disconnect the AC power cord.
3. Remove the computer's cover and locate the DIMM sockets (see Figure 18).

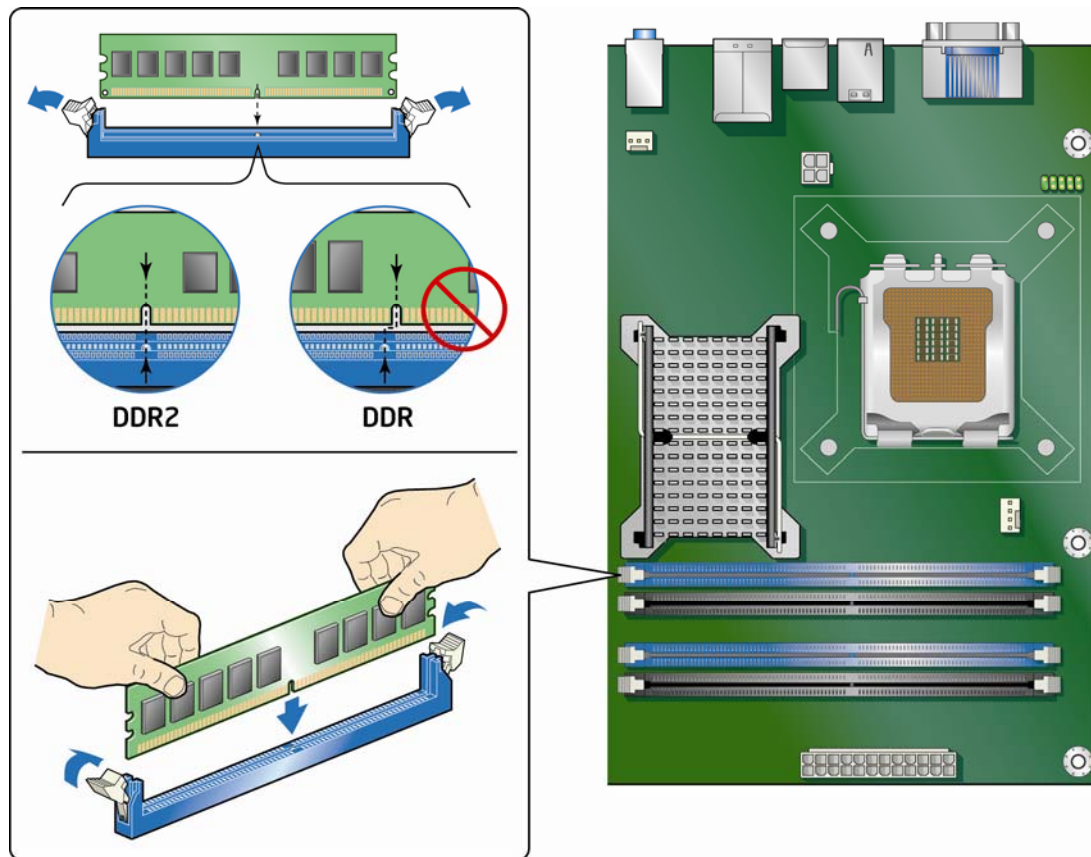

Figure 18. Installing a DIMM

4. Make sure the clips at either end of the DIMM socket(s) are pushed outward to the open position.
5. Holding the DIMM by the edges, remove it from its anti-static package.
6. Position the DIMM above the socket. Align the small notch at the bottom edge of the DIMM with the keys in the socket (see inset in Figure 18).

7. Insert the bottom edge of the DIMM into the socket.
8. When the DIMM is inserted, push down on the top edge of the DIMM until the retaining clips snap into place. Make sure the clips are firmly in place.
9. Replace the computer's cover and reconnect the AC power cord.

Removing DIMMs

To remove a DIMM, follow these steps:

1. Observe the precautions in "Before You Begin" on page 29.
2. Turn off all peripheral devices connected to the computer. Turn off the computer.
3. Remove the AC power cord from the computer.
4. Remove the computer's cover.
5. Gently spread the retaining clips at each end of the DIMM socket. The DIMM pops out of the socket.
6. Hold the DIMM by the edges, lift it away from the socket, and store it in an anti-static package.
7. Reinstall and reconnect any parts you removed or disconnected to reach the DIMM sockets.
8. Replace the computer's cover and reconnect the AC power cord.

Installing and Removing a PCI Express x16 Card



CAUTION

When installing a PCI Express x16 card on the Desktop Board, ensure that the card is fully seated in the PCI Express x16 connector before you power on the system. If the card is not fully seated in the PCI Express connector, an electrical short may result across the PCI Express connector pins. Depending on the over-current protection of the power supply, certain Desktop Board components and/or traces may be damaged.

Installing a PCI Express x16 Card

1. Observe the precautions in "Before You Begin" on page 29.
2. Place the card in the PCI Express x16 connector (Figure 19, A) and press down on the card until it is completely seated in the connector and the card retention notch on the card snaps into place around the retention mechanism pin on the connector.
3. Secure the card's metal bracket to the chassis back panel with a screw (Figure 19, B).

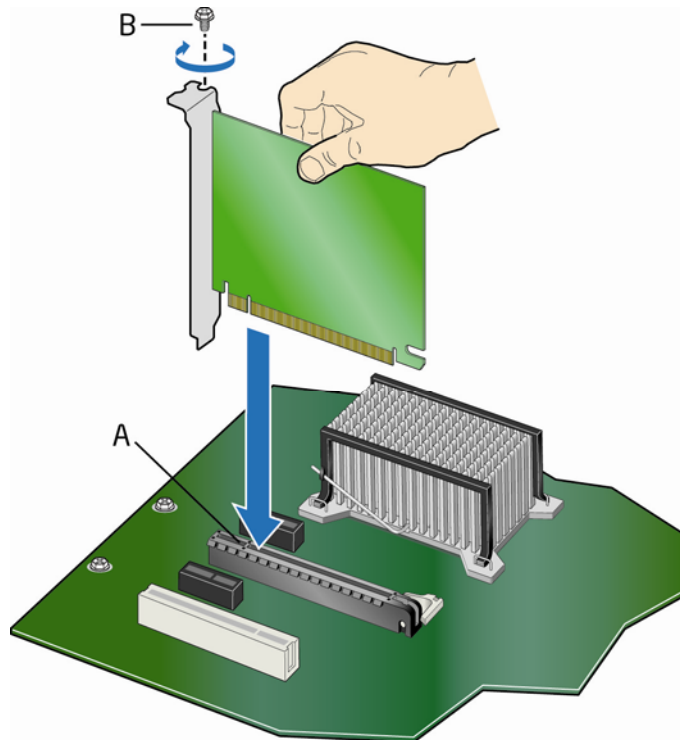

OM21145

Figure 19. Installing a PCI Express x16 Card

Removing the PCI Express x16 Card

Follow these instructions to remove the PCI Express x16 card from the connector:

1. Observe the precautions in "Before You Begin" on page 29.
2. Remove the screw (Figure 20, A) that secures the card's metal bracket to the chassis back panel.
3. Push the card ejector lever down using the tip of a pencil or similar tool (Figure 20, B) in the notch. This will release the card from the connector (C).
4. Pull the card straight up.

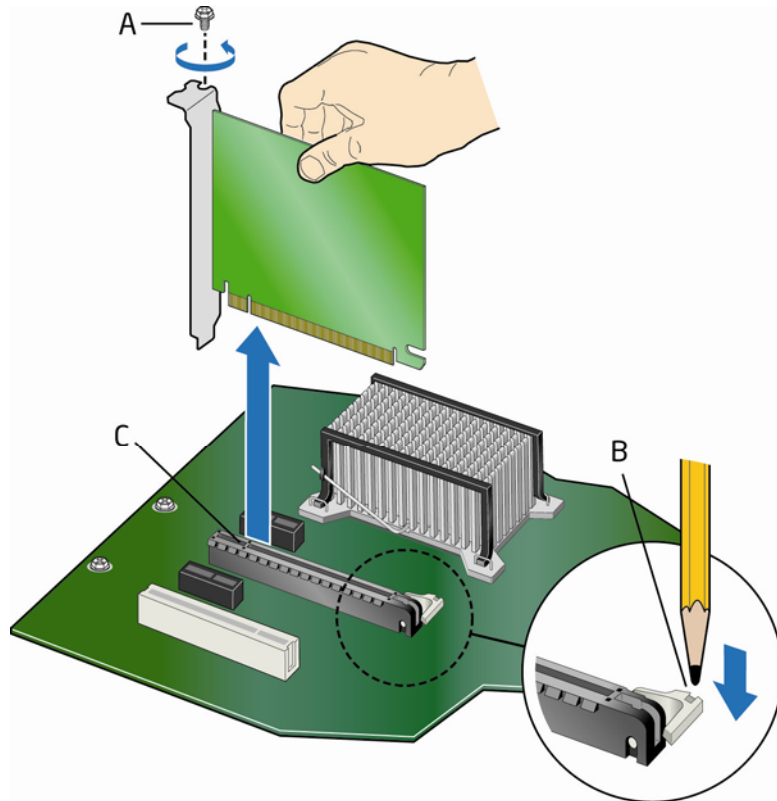

OM21145

Figure 20. Removing a PCI Express x16 Card

Connecting Serial ATA (SATA) Cables

SATA cables support the Serial ATA protocol. Each cable can be used to connect a single SATA drive to the Desktop Board. For correct cable function:

1. Observe the precautions in "Before You Begin" on page 29.
2. Attach one end the SATA cable to one of the SATA connectors on the board (Figure 21, A).
3. Attach the other end of the SATA cable to the SATA drive (Figure 21, B).

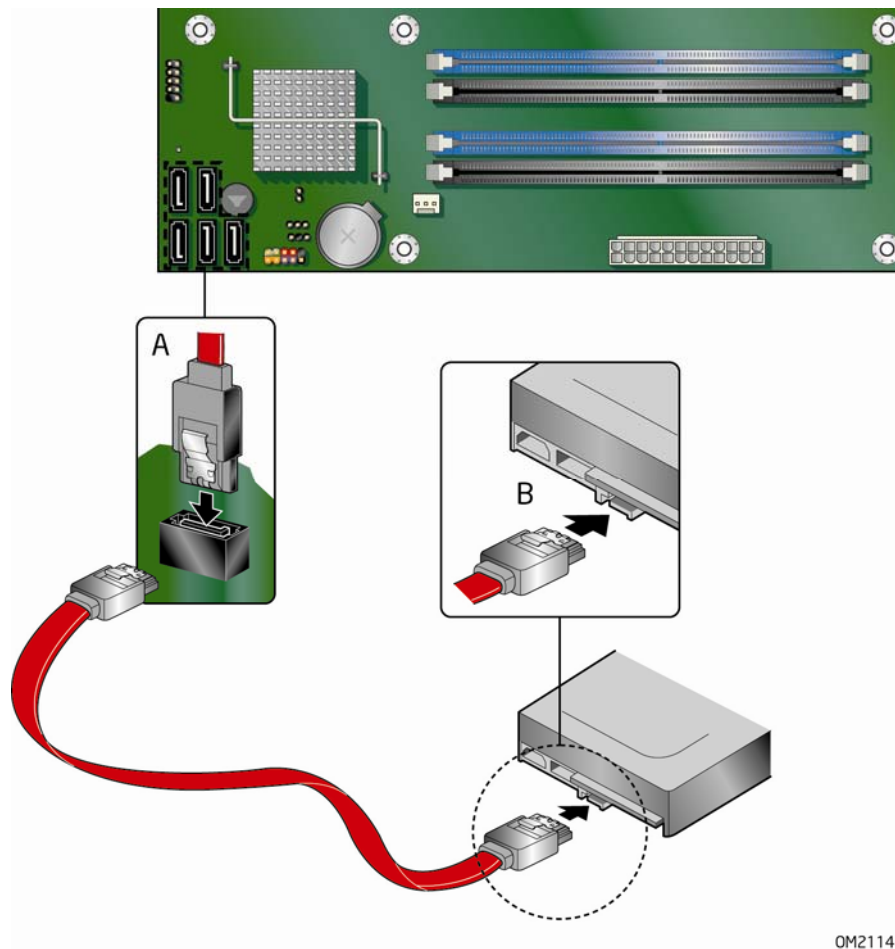
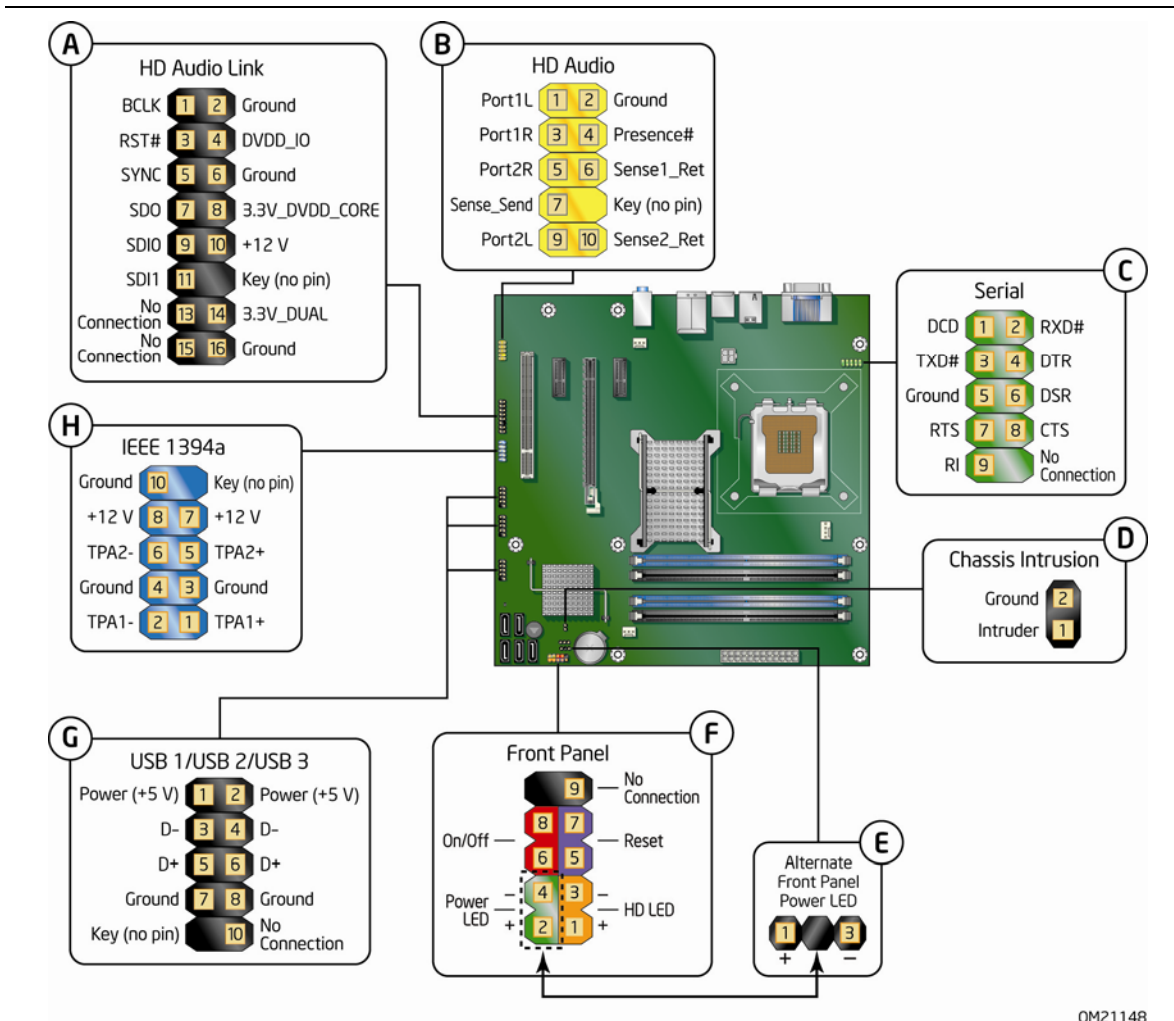

Figure 21. Connecting a Serial ATA Cable

Connecting to Internal Headers

Before connecting cables to the internal headers, observe the precautions in “Before You Begin” on page 29. Figure 22 shows the location of the internal headers and connectors.



OM21148

Item	Description	Item	Description
A	HD Audio Link	E	Alternate front panel power LED
B	HD Audio	F	Front panel
C	Serial	G	USB 2.0 (3)
D	Chassis intrusion	H	IEEE 1394a

Figure 22. Internal Headers

HD Audio Link Header

See Figure 22, A for the location of the HD Audio Link header. Table 6 shows the pin assignments for the header.

Table 6. HD Audio Link Header Signal Names

Pin	Signal Name	Pin	Signal Name
1	BCLK	2	Ground
3	RST#	4	DVDD_IO
5	SYNC	6	Ground
7	SDO	8	3.3V_DVDD_CORE
9	SDI0	10	+12 V
11	SDI1	12	Key
13	No Connection	14	3.3V_DUAL
15	No Connection	16	Ground

Front Panel Audio Header

The front panel audio header supports both High Definition (HD) Audio and AC'97 Audio. Table 7 shows the pin assignments and signal names for HD Audio and Table 8 shows the pin assignments and signal names for AC'97 Audio.

Table 7. Front Panel Audio Header Signal Names for HD Audio

Pin	Signal Name	Pin	Signal Name
1	PORT 1L	2	GND
3	PORT 1R	4	PRESENCE#
5	PORT 2R	6	SENSE1_RETURN
7	SENSE_SEND	8	KEY (no pin)
9	PORT 2L	10	SENSE2_RETURN

Table 8. Front Panel Audio Header Signal Names for AC'97 Audio

Pin	Signal Name	Pin	Signal Name
1	MIC	2	AUD_GND
3	MIC_BIAS	4	AUD_GND
5	FP_OUT_R	6	FP_RETURN_R
7	AUD_5V	8	KEY (no pin)
9	FP_OUT_L	10	FP_RETURN_L

Serial Port Header

See Figure 22, D for the location of the serial port header. Table 9 shows the pin assignments for the header.

Table 9. Serial Port Header Signal Names

Pin	Signal Name	Pin	Signal Name
1	DCD	2	RXD#
3	TXD#	4	DTR
5	Ground	6	DSR
7	RTS	8	CTS
9	RI	10	No Connection

Chassis Intrusion Header

Figure 22, D on page 46 shows the location of the chassis intrusion header. This header can be connected to a mechanical switch on the chassis to detect if the chassis cover is removed. Table 10 shows the pin assignments for the chassis intrusion header.

Table 10. Chassis Intrusion Header Signal Names

Pin	Description
1	Intruder
2	Ground

Alternate Front Panel Power LED Header

Figure 22, E shows the location of the alternate front panel power LED header. Pins 1 and 3 of this header duplicate the signals on pins 2 and 4 of the front panel header. If your chassis has a three-pin power LED cable, connect it to this header. Table 11 shows the pin assignments for the alternate front panel header.

Table 11. Alternate Front Panel Power LED Header Signal Names

Pin	Description	In/Out
1	Front panel green LED	Out
2	No pin	
3	Front panel yellow LED	Out

Front Panel Header

See Figure 22, F for the location of the multi-colored front panel header. Table 12 shows the pin assignments for the front panel header.

Table 12. Front Panel Header Signal Names

Pin	Description	In/Out	Pin	Description	In/Out
Hard Drive Activity LED			Power LED		
1	Hard disk LED pull-up to +5 V	Out	2	Front panel green LED	Out
3	Hard disk active LED	Out	4	Front panel yellow LED	Out
Reset Switch			On/Off Switch		
5	Ground		6	Power switch	In
7	Reset switch	In	8	Ground	
Power			Not Connected		
9	Power	Out	10	No pin	

USB 2.0 Headers

See Figure 22, G for the location of the three USB 2.0 headers. Table 13 shows the pin assignments for each USB 2.0 header. Each USB header can be used to connect two USB devices.

Table 13. USB 2.0 Header Signal Names

USB Port A		USB Port B	
Pin	Signal Name	Pin	Signal Name
1	Power (+5 V)	2	Power (+5 V)
3	D-	4	D-
5	D+	6	D+
7	Ground	8	Ground
9	Key	10	No Connection

Note: USB ports may be assigned as needed.



NOTE

Computer systems that have an unshielded cable attached to a USB port might not meet FCC Class B requirements, even if no device or a low-speed USB device is attached to the cable. Use a shielded cable that meets the requirements for a full-speed USB device.

IEEE 1394a Header

See Figure 22, H for the location of the IEEE 1394a header. Table 14 shows the pin assignments for the header.

Table 14. IEEE 1394a Header Signal Names

Pin	Signal Name	Pin	Signal Name
1	TPA1+	2	TPA1-
3	Ground	4	Ground
5	TPA2+	6	TPA2-
7	+12 V	8	+12 V
9	Key (no pin)	10	Ground

Connecting to the Audio System

After installing the Analog Devices audio driver from the Intel Express Installer DVD-ROM, the multi-channel audio feature can be enabled. Figure 23 shows the default back panel audio connector assignments. The audio connectors are retaskable via audio software. Table 3 on page 16 lists the supported audio connector assignments.

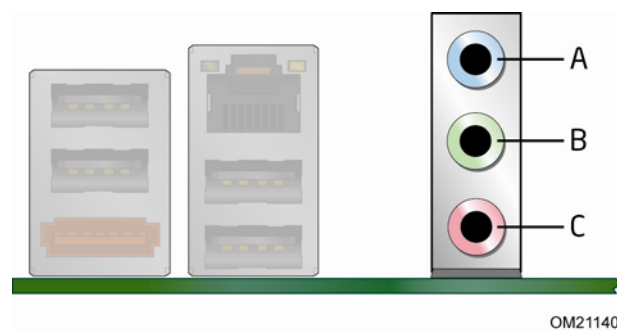

Item	Description
A	Line In
B	Line Out
C	Mic In

Figure 23. Back Panel Audio Connectors



NOTE

The back panel line out connector is designed to power either headphones or amplified speakers only. Poor audio quality may occur if passive (non-amplified) speakers are connected to this output.

Connecting Chassis Fan and Power Supply Cables

Chassis Fan Cables

Connect chassis fan cables to the chassis fan headers on the Desktop Board. Figure 24 shows the location of the chassis fan headers.

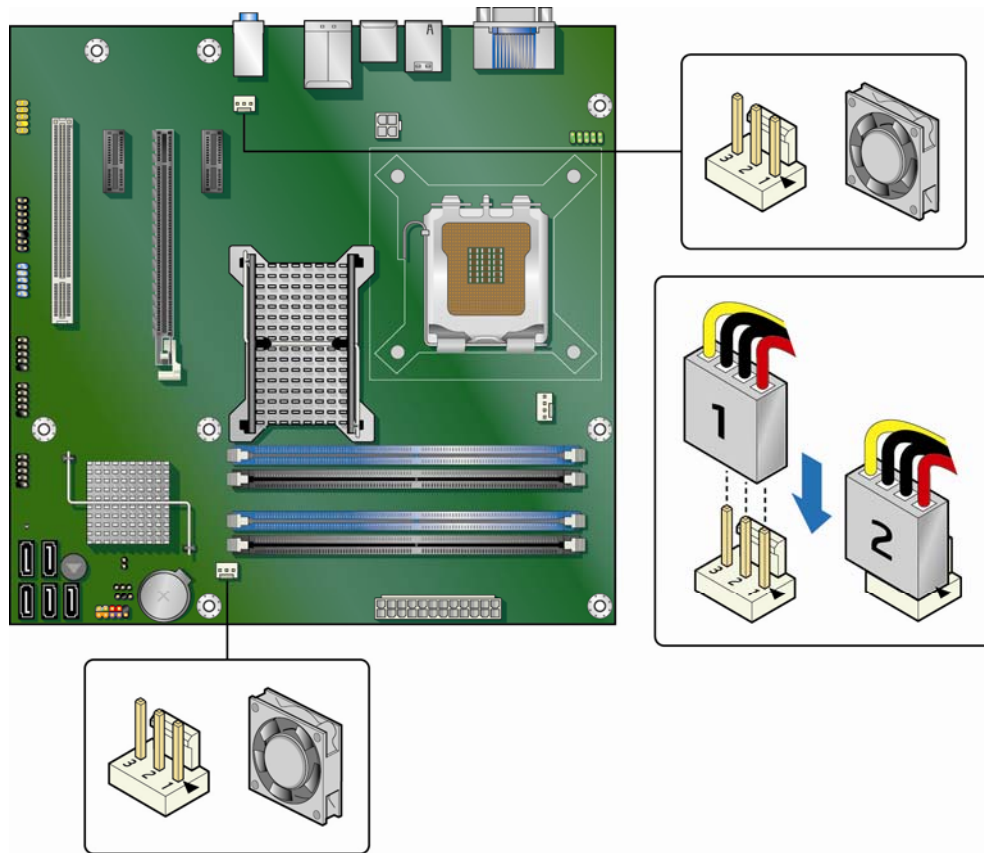

OM21149

Figure 24. Location of the Chassis Fan Headers

Power Supply Cables



CAUTION

Failure to use an appropriate power supply and/or not connecting the 12 V (2 x 2 pin) power connector to the Desktop Board may result in damage to the board or the system may not function properly.

The 2 x 12 pin main power connector on the Desktop Board is backwards compatible with ATX12V power supplies with 2 x 10 connectors. Figure 25 shows the location of the Desktop Board power connectors.

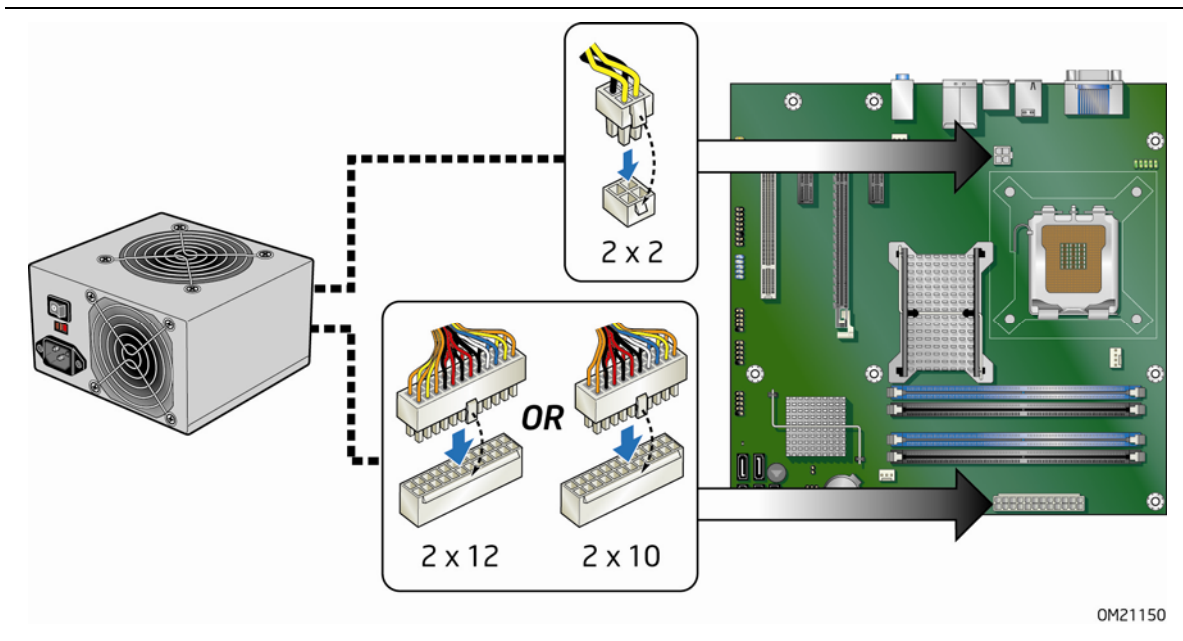

Figure 25. Connecting Power Supply Cables

1. Observe the precautions in "Before You Begin" on page 29.
2. Connect the main power supply cable to the 2 x 12 pin connector.
3. Connect the 12 V processor core voltage power supply cable to the 2 x 2 pin connector.

Setting the BIOS Configuration Jumper



NOTE

Always turn off the power and unplug the power cord from the computer before moving the jumper. Moving the jumper with the power on may result in unreliable computer operation.

Figure 26 shows the location of the Desktop Board's BIOS configuration jumper block.

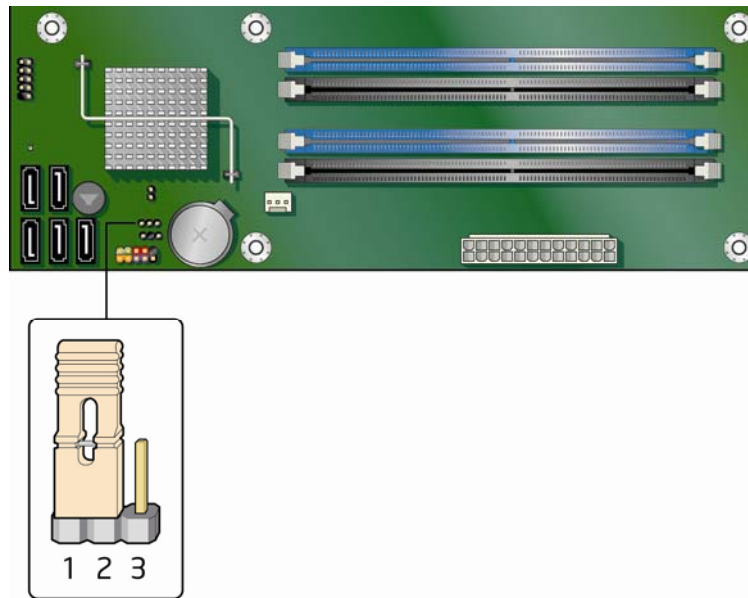

OM21151

Figure 26. Location of the BIOS Configuration Jumper Block

The three-pin BIOS jumper block enables all board configurations to be done in the BIOS Setup program. Table 15 shows the jumper settings for the BIOS Setup program modes.

Table 15. Jumper Settings for the BIOS Setup Program Modes

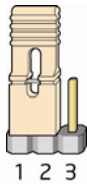
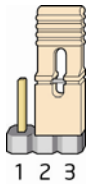
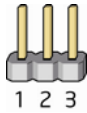
Jumper Setting	Mode	Description
	Normal (default) (1-2)	The BIOS uses the current configuration and passwords for booting.
	Configure (2-3)	After the Power-On Self-Test (POST) runs, the BIOS displays the Maintenance Menu. Use this menu to clear passwords.
	Recovery (None)	The BIOS recovers data in the event of a failed BIOS update.

Clearing or Changing Passwords

This section describes how to clear or change the BIOS security passwords (user and supervisor).

This procedure assumes that the board is installed in the computer and the configuration jumper block is set to normal mode.

1. Observe the precautions in "Before You Begin" on page 29.
2. Turn off all peripheral devices connected to the computer. Turn off the computer. Disconnect the computer's power cord from the AC power source (wall outlet or power adapter).
3. Remove the computer cover.
4. Find the configuration jumper block (see Figure 26).
5. Place the jumper on pins 2-3 as shown below.

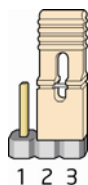

6. Replace the cover, plug in the computer, turn on the computer, and allow it to boot.
7. The computer starts the Setup program. Setup displays the Maintenance menu.
8. Use the arrow keys to select Clear Passwords. Press <Enter> and Setup displays a pop-up screen requesting that you confirm clearing the password. Select Yes and press <Enter>. Setup displays the maintenance menu again.

9. Press <F10> to save the current values and exit Setup.
10. Turn off the computer. Disconnect the computer's power cord from the AC power source.
11. Remove the computer cover.
12. To restore normal operation, place the jumper on pins 1-2 as shown below.

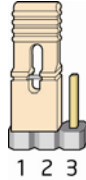

13. Replace the cover, plug in the computer, and turn on the computer.

Replacing the Battery

A coin-cell battery (CR2032) powers the real-time clock and CMOS memory. When the computer is not plugged into a wall socket, the battery has an estimated life of three years. When the computer is plugged in, the standby current from the power supply extends the life of the battery. The clock is accurate to ± 13 minutes/year at 25 °C with 3.3 VSB applied.

When the voltage drops below a certain level, the BIOS Setup program settings stored in CMOS RAM (for example, the date and time) might not be accurate. Replace the battery with an equivalent one. Figure 27 on page 60 shows the location of the battery.



NOTE

The Intel TPM uses the onboard coin-cell battery (CR2032) to maintain its monotonic counters. One major function of the monotonic counters is for anti-replay protection of the internal Intel TPM data. If the battery is removed or exhausted, the Intel TPM data will be deleted in accordance with Trusted Computing Group guidelines. Please read the Intel TPM user guide and back-up Intel TPM keys and data before removing the battery.



CAUTION

Risk of explosion if the battery is replaced with an incorrect type. Batteries should be recycled where possible. Disposal of used batteries must be in accordance with local environmental regulations.



PRÉCAUTION

Risque d'explosion si la pile usagée est remplacée par une pile de type incorrect. Les piles usagées doivent être recyclées dans la mesure du possible. La mise au rebut des piles usagées doit respecter les réglementations locales en vigueur en matière de protection de l'environnement.



FORHOLDSREGEL

Eksplodingsfare, hvis batteriet erstattes med et batteri af en forkert type. Batterier bør om muligt genbruges. Bortskaffelse af brugte batterier bør foregå i overensstemmelse med gældende miljølovgivning.



OBS!

Det kan oppstå eksplosjonsfare hvis batteriet skiftes ut med feil type. Brukte batterier bør kastes i henhold til gjeldende miljølovgivning.



VIKTIGT!

Risk för explosion om batteriet ersätts med felaktig batterityp. Batterier ska kasseras enligt de lokala miljövårdsbestämmelserna.



VARO

Räjähdyksvaara, jos pariston tyyppi on väärä. Paristot on kierrätettävä, jos se on mahdollista. Käytetyt paristot on hävitettävä paikallisten ympäristömääräysten mukaisesti.



VORSICHT

Bei falschem Einsetzen einer neuen Batterie besteht Explosionsgefahr. Die Batterie darf nur durch denselben oder einen entsprechenden, vom Hersteller empfohlenen Batterietyp ersetzt werden. Entsorgen Sie verbrauchte Batterien den Anweisungen des Herstellers entsprechend.



AVVERTIMENTO

Esiste il pericolo di un esplosione se la pila non viene sostituita in modo corretto. Utilizzare solo pile uguali o di tipo equivalente a quelle consigliate dal produttore. Per disfarsi delle pile usate, seguire le istruzioni del produttore.



PRECAUCIÓN

Existe peligro de explosión si la pila no se cambia de forma adecuada. Utilice solamente pilas iguales o del mismo tipo que las recomendadas por el fabricante del equipo. Para deshacerse de las pilas usadas, siga igualmente las instrucciones del fabricante.



WAARSCHUWING

Er bestaat ontploffingsgevaar als de batterij wordt vervangen door een onjuist type batterij. Batterijen moeten zoveel mogelijk worden gerecycled. Houd u bij het weggoaien van gebruikte batterijen aan de plaatselijke milieuwetgeving.



ATENÇÃO

Haverá risco de explosão se a bateria for substituída por um tipo de bateria incorreto. As baterias devem ser recicladas nos locais apropriados. A eliminação de baterias usadas deve ser feita de acordo com as regulamentações ambientais da região.



AŠCIAROŽNÁŠĆ

Існуе рызыка выбуху, калі заменены акумулятар неправільнага тыпу. Акумулятары павінны, па магчымасці, перепрацоўвацца. Пазбаўляцца ад старых акумулятараў патрэбна згодна з мясцовым заканадаўствам па экалогіі.



UPOZORNĚNÍ

V případě výměny baterie za nesprávný druh může dojít k výbuchu. Je-li to možné, baterie by měly být recyklovány. Baterie je třeba zlikvidovat v souladu s místními předpisy o životním prostředí.



Προσοχή

Υπάρχει κίνδυνος για έκρηξη σε περίπτωση που η μπαταρία αντικατασταθεί από μία λανθασμένου τύπου. Οι μπαταρίες θα πρέπει να ανακυκλώνονται όταν κάτι τέτοιο είναι δυνατό. Η απόρριψη των χρησιμοποιημένων μπαταριών πρέπει να γίνεται σύμφωνα με τους κατά τόπο περιβαλλοντικούς κανονισμούς.



VIGYÁZAT

Ha a telepet nem a megfelelő típusú telepre cseréli, az felrobbanhat. A telepeket lehetőség szerint újra kell hasznósítani. A használt telepeket a helyi környezetvédelmi előírásoknak megfelelően kell kiselejtezni.



注意

異なる種類の電池を使用すると、爆発の危険があります。リサイクルが可能な地域であれば、電池をリサイクルしてください。使用後の電池を破棄する際には、地域の環境規制に従ってください。



AWAS

Risiko letupan wujud jika bateri digantikan dengan jenis yang tidak betul. Bateri sepatutnya dikitar semula jika boleh. Pelupusan bateri terpakai mestilah mematuhi peraturan alam sekitar tempatan.



OSTRZEŻENIE

Istnieje niebezpieczeństwo wybuchu w przypadku zastosowania niewłaściwego typu baterii. Zużyte baterie należy w miarę możliwości utylizować zgodnie z odpowiednimi przepisami ochrony środowiska.



PRECAUȚIE

Risc de explozie, dacă bateria este înlocuită cu un tip de baterie necorespunzător. Bateriile trebuie reciclate, dacă este posibil. Depozitarea bateriilor uzate trebuie să respecte reglementările locale privind protecția mediului.



ВНИМАНИЕ

При использовании батареи несоответствующего типа существует риск ее взрыва. Батареи должны быть утилизированы по возможности. Утилизация батарей должна проводиться по правилам, соответствующим местным требованиям.



UPOZORNENIE

Ak batériu vymeníte za nesprávny typ, hrozí nebezpečenstvo jej výbuchu. Batérie by sa mali podľa možnosti vždy recyklovať. Likvidácia použitých batérií sa musí vykonávať v súlade s miestnymi predpismi na ochranu životného prostredia.



POZOR

Zamenjava baterije z baterijo drugačnega tipa lahko povzroči eksplozijo. Če je mogoče, baterije reciklirajte. Rabljene baterije zavrzite v skladu z lokalnimi okoljevarstvenimi predpisi.



คำเตือน

ระวังการระเบิดที่เกิดจากเปลี่ยนแบตเตอรี่ผิดประเภท หากเป็นไปได้ ควรนำแบตเตอรี่ไปรีไซเคิล การทิ้งแบตเตอรี่ใช้แล้วต้องเป็นไปตามกฎข้อบังคับด้านสิ่งแวดล้อมของท้องถิ่น.



UYARI

Yanlış türde pil takıldığında patlama riski vardır. Piller mümkün olduğunda geri dönüştürülmelidir. Kullanılmış piller, yerel çevre yasalarına uygun olarak atılmalıdır.



ОСТОРОГА

Використовуйте батареї правильного типу, інакше існуватиме ризик вибуху. Якщо можливо, використані батареї слід утилізувати. Утилізація використаних батарей має бути виконана згідно місцевих норм, що регулюють охорону довкілля.



UPOZORNĚNÍ

V případě výměny baterie za nesprávný druh může dojít k výbuchu. Je-li to možné, baterie by měly být recyklovány. Baterie je třeba zlikvidovat v souladu s místními předpisy o životním prostředí.



ETTEVAATUST

Kui patarei asendatakse uue ebasobivat tüüpi patareiga, võib tekkida plahvatusoht. Tühjad patareid tuleb võimaluse korral viia vastavasse kogumispunkti. Tühjade patareide äraviskamisel tuleb järgida kohalikke keskkonnakaitse alaseid reegleid.



FIGYELMEZTETÉS

Ha az elemet nem a megfelelő típusúra cseréli, felrobbanhat. Az elemeket lehetőség szerint újra kell hasznosítani. A használt elemeket a helyi környezetvédelmi előírásoknak megfelelően kell kiselejtezni.



UZMANĪBU

Pastāv eksplozijas risks, ja baterijas tiek nomainītas ar nepareiza veida baterijām. Ja iespējams, baterijas vajadzētu nodot attiecīgos pieņemšanas punktus. Bateriju izmešanai atkritumos jānotiek saskaņā ar vietējiem vides aizsardzības noteikumiem.



DĒMESIO

Naudojant netinkamo tipo baterijas įrenginys gali sprogti. Kai tik įmanoma, baterijas reikia naudoti pakartotinai. Panaudotas baterijas išmesti būtina pagal vietinius aplinkos apsaugos nuostatus.



ATTENZJONI

Riskju ta' splużjoni jekk il-batterija tinbidel b'tip ta' batterija mhux korrett. Il-batteriji għandhom jiġu riċiklati fejn hu possibbli. Ir-rimi ta' batteriji użati għandu jsir skond ir-regolamenti ambjentali lokali.



OSTRZEŻENIE

Ryzyko wybuchu w przypadku wymiany na baterie niewłaściwego typu. W miarę możliwości baterie należy poddać recyklingowi. Zużytych baterii należy pozbywać się zgodnie z lokalnie obowiązującymi przepisami w zakresie ochrony środowiska.

To replace the battery, follow these steps:

1. Observe the precautions in "Before You Begin" (see page 29).
2. Turn off all peripheral devices connected to the computer. Disconnect the computer's power cord from the AC power source (wall outlet or power adapter).
3. Remove the computer cover.
4. Locate the battery on the board (see Figure 27).
5. With a medium flat-bladed screwdriver, gently pry the battery free from its connector. Note the orientation of the "+" and "-" on the battery.
6. Install the new battery in the connector, orienting the "+" and "-" correctly.
7. Replace the computer cover.

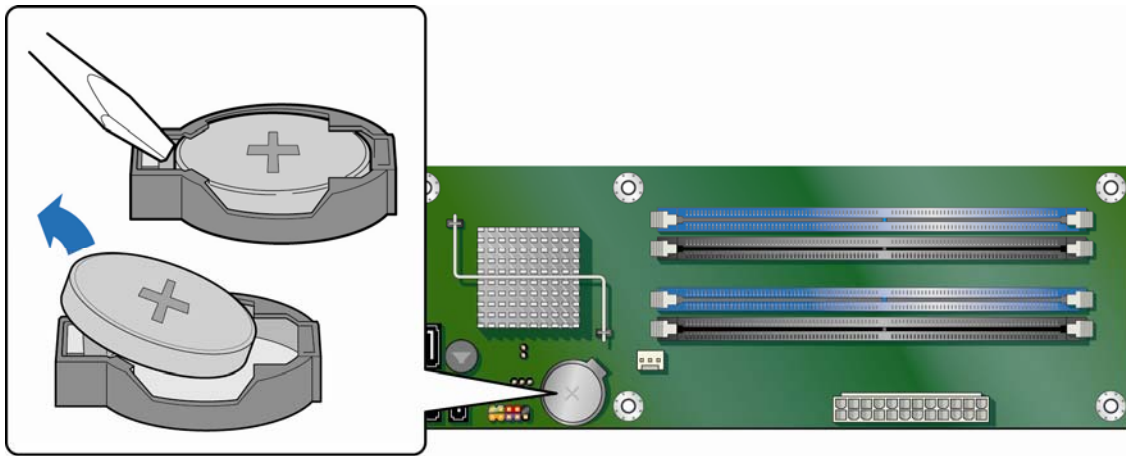

OM21152

Figure 27. Removing the Battery

3 Updating the BIOS

The BIOS Setup program can be used to view and change the BIOS settings for the computer. You can access the BIOS Setup program by pressing the <F2> key after the Power-On Self-Test (POST) memory test begins and before the operating system boot begins.

This chapter tells you how to update the BIOS by either using the Intel Express BIOS Update utility or the Iflash Memory Update utility, and how to recover the BIOS if an update fails.

Updating the BIOS with the Intel[®] Express BIOS Update Utility

With the Intel Express BIOS Update utility you can update the system BIOS while in the Windows environment. The BIOS file is included in an automated update utility that combines the functionality of the Intel[®] Flash Memory Update Utility and the ease of use of Windows-based installation wizards.

To update the BIOS with the Intel Express BIOS Update utility:

1. Go to the Intel World Wide Web site:
<http://support.intel.com/support/motherboards/desktop/>
2. Navigate to the Intel Desktop Board DQ45CB page. Under the "Software and drivers" heading, click on "Latest BIOS" to locate the latest BIOS files. Click on the "BIOS Update" link and select the Express BIOS Update file.
3. Download the file to your hard drive. (You can also save this file to a removable USB device. This is useful if you are updating the BIOS for multiple identical systems.)
4. Close all other applications. This step is required. Your system will be rebooted at the last Express BIOS Update window.
5. Double-click the executable file from the location on your hard drive where it was saved. This runs the update program.
6. Follow the instructions provided in the dialog boxes to complete the BIOS update.

Updating the BIOS with the ISO Image BIOS Update File or the Iflash Memory Update Utility

You can use the information in this section to update the BIOS using either the Iflash Memory Update Utility or the ISO Image BIOS update file.

Obtaining the BIOS Update File

You can update to a new version of the BIOS by using the ISO Image BIOS update file (recommended), or Iflash BIOS update file.

The ISO Image BIOS update file is a standardized image of a bootable CD-ROM that can be used to create a bootable CD that will update the BIOS.

The Iflash BIOS update file is a compressed file that contains the files you need to update the BIOS. The Iflash BIOS update file contains:

- New BIOS file (including the Intel® Management Engine (Intel® ME) Firmware Image))
- Intel® Integrator Toolkit Configuration File (optional)
- Intel Flash Memory Update Utility

You can obtain either of these files through your computer supplier or by navigating to the Intel Desktop Board DQ45CB page on the Intel World Wide Web site at <http://support.intel.com/support/motherboards/desktop>.

Navigate to the Intel Desktop Board DQ45CB page. Under the "Software and drivers" heading, click on "Latest BIOS" to locate the latest BIOS files. Click on the "BIOS Update" link and select the ISO Image BIOS Update file or the Iflash BIOS Update file.

Updating the BIOS with the ISO Image BIOS Update File

The ISO Image BIOS update allows for the update of an Intel® Desktop Board BIOS to the latest production release regardless of the operating system installed on the computer's hard drive and without the need to remove the BIOS configuration jumper. It requires a blank CD-R, a read/writeable CD drive, and software capable of uncompressing and writing the ISO image file to CD.

The image uses ISOLINUX* bootloader and automatically launches a script to upgrade the BIOS via the Iflash utility.

**CAUTION**

Do not interrupt the process or the system may not function properly.

Follow these instructions to upgrade the BIOS using the ISO Image BIOS file:

1. Download the ISO Image BIOS file.
2. Using software capable of uncompressing and writing an ISO image file to CD, burn the data to a blank CD.

**NOTE**

Copying the ISO Image BIOS file to CD will not work. The completed CD should contain multiple files and a directory.

3. Insert the CD that was created in the CD-ROM drive of the computer to be upgraded and boot the system.
4. When the "Press ENTER to continue booting from CD-ROM" prompt appears, press the Enter key. The system will boot from the hard drive if no key is pressed within 15 seconds.
5. At the "Welcome to the Intel Desktop Board BIOS Upgrade CD-ROM" page, press any key to confirm the BIOS upgrade operation.
6. Wait for the BIOS upgrade process to complete.

**CAUTION**

DO NOT POWER DOWN YOUR COMPUTER before the update is complete. The update may take up to 5 minutes.

Updating the BIOS with the Iflash Memory Update Utility

With the Iflash Memory update utility you can update the system BIOS from a bootable CD-ROM, bootable USB flash drive, or other bootable USB media. The utility available on the Intel World Wide Web site provides a simple method for creating a bootable CD-ROM that will automatically update your BIOS. The Iflash BIOS update files can also be extracted locally to your hard drive and copied to a bootable USB flash drive or other bootable USB media.

The Iflash Memory update utility allows you to:

- Update the BIOS and Intel Management Engine in flash memory
- Update the language section of the BIOS

**NOTE**

Review the instructions distributed with the update utility before attempting a BIOS update.



CAUTION

Do not interrupt the process or the system may not function properly.

1. Uncompress the BIOS update file and copy the .BIO file, IFLASH.EXE, and .ITK file (optional) to a bootable USB flash drive or other bootable USB media.
2. Configure the BIOS or use the F10 option during POST to boot to the USB device.
3. Manually run the IFLASH.EXE file from the USB device and manually update the BIOS.

Recovering the BIOS

It is unlikely that anything will interrupt the BIOS update; however, if an interruption occurs, the BIOS could be damaged. Due to BIOS size and recovery requirements, a CD-R with the .BIO file in the root directory will be required.



NOTE

For more information about updating the Intel Desktop Board BIOS or recovering from a BIOS update failure, go to

<http://support.intel.com/support/motherboards/desktop/sb/CS-022312.htm>.

4 Configuring for RAID (Intel[®] Matrix Storage Technology (Intel[®] MST))



NOTE

Intel Matrix Storage Technology requires Microsoft Windows Vista or Microsoft Windows XP operating system and SATA hard drives.

Configuring the BIOS for Intel Matrix Storage Technology

1. Assemble your system and attach one or more SATA hard drives to the SATA connectors.
2. Enter system BIOS Setup by pressing the <F2> key after the Power-On-Self-Test (POST) memory tests begin.
3. Go to **Advanced** → **Drive Configuration** → **Configure SATA as**; ensure that **RAID** is selected.
4. Then save your settings by pressing <F10>.

Creating Your RAID Set

1. Upon re-boot, you will see the following Intel Matrix Storage Manager option ROM status message on the screen: Press <Ctrl-I> to enter the RAID Configuration Utility. Press <Ctrl-I> and enter the RAID Configuration Utility.
2. In the Intel Matrix Storage Manager option ROM Main Menu, select option #1: Create RAID Volume. Enter a volume name and press <Enter>. **NOTE:** The RAID Volume name must be in English alphanumeric ASCII characters.
3. Use the arrow keys to select RAID 0 or RAID 1 (if only two SATA drives are available), RAID 5 and RAID 10 (these options will only appear if three or four SATA drives are installed respectively). Press <Enter> once you have selected the RAID LEVEL.
4. Select the drives to be used in the RAID array (only if there are more than two drives available) and press <Enter>.
5. Select the strip size, if necessary, and press <Enter>.
6. Enter the size of the volume (if you enter less than the maximum volume size, you can then create a second RAID array on the remaining portion of your volume) and press <Enter>.
7. Finally, press <Enter> to **Create Volume**.
8. Exit the Option ROM user interface by pressing <Esc> or going to the EXIT option in the MAIN MENU.

Loading the Intel Matrix Storage Technology RAID Drivers and Software

1. Begin Windows Setup by booting from the Windows installation CD.
2. If you will be using Microsoft Windows XP, press <F6> at the beginning of Windows Setup to install a third-party SCSI or RAID driver. When prompted, insert the diskette labeled Intel Matrix Storage Technology RAID Driver. Install the Intel® ICH10DO SATA RAID Controller driver.

or

If you will be using Microsoft Windows Vista, follow the setup installation steps until you reach the section "Where do you want to install Windows?". Click on the "Load Drivers" option and insert the diskette labeled Intel Matrix Storage Technology RAID Driver (Note: If you do not have a floppy drive, you can download the driver from <http://support.intel.com/support/motherboards/desktop/> to a recordable CD or USB storage media). Select to install the Intel ICH10DO SATA RAID Controller driver.

3. Finish the Windows installation and install all necessary drivers.
4. Install the Intel Matrix Storage Console software via the Intel Express Installer CD included with your desktop board or after downloading it from the Internet at <http://support.intel.com/support/motherboards/desktop/>. The Intel Matrix Storage Console software can be used to manage the RAID configuration.

Setting Up a "RAID Ready" System

The Intel Matrix Storage Technology Console software offers the flexibility to upgrade from a single Serial ATA drive to RAID without reinstalling the operating system, when a second SATA hard drive is added to the system.

Follow the steps described in the headings from this section: "Configuring the BIOS for Intel Matrix Storage Technology" and "Loading the Intel Matrix Storage Technology RAID Drivers and Software".

Once additional SATA drives have been added, open the Intel Matrix Storage Technology Console Software and follow the directions to update to a RAID setup.

5 Configuring for Intel® Rapid Recover Technology (Intel® RRT)

Intel Rapid Recover technology utilizes RAID 1 (mirroring) functionality to copy data from a designated master drive to a designated recovery drive. The master and recovery drives must span 100 percent of the available hard drive space of an array, and only one recovery volume can be present on a system.

You can select whether you want the master drive data to be copied to the recovery drive continuously or on request. When using the Continuous Update policy, changes made to the data on the master drive while the recovery drive is disconnected or offline are automatically copied to the recovery drive when it is reconnected.

When using the Update On Request policy, the master drive data can be restored to a previous state by copying the data on the recovery drive back to the master drive.

Enabling Intel Rapid Recover Technology



NOTE

Intel Rapid Recover Technology does not support RAID 5.

Intel Rapid Recover Technology can be Enabled or Disabled in the system BIOS menu. To enable Intel Rapid Recover Technology, complete following steps:

1. Enter the BIOS menu by pressing the <F2> key early during system POST.
2. Go to **Advanced** → **Drive Configuration**.
3. For the setting **Intel Rapid Recover Technology**, select to enable it.
4. For the setting **Configure SATA as**, ensure it is set to **RAID**.



CAUTION

*If **Configure SATA as** was previously not set to **RAID** and you already have an operating system installed, you must reinstall it. Follow the instructions in Chapter 4 to install the Intel Matrix Storage RAID driver during the operating system installation.*

5. Exit and save settings. Proceed to "Creating a Recovery Volume."

Creating a Recovery Volume

A recovery volume consists of two disks – a master disk and a recovery disk.

A recovery volume can be created with either the RAID Option ROM (OROM) or the Intel® Matrix Storage Console application.

Creating a Recovery Volume Using the RAID Option ROM

To create a recovery volume using the RAID OROM, complete the following steps:

1. Enter the RAID OROM by pressing the <Ctrl> and <I> keys simultaneously when prompted during system POST.
2. Under the **Create RAID** volume option, select the option to create a recovery volume.
3. Select the master disk and the recovery disk.



NOTE

The master disk size must be less than or equal to the recovery disk size.

The RAID OROM Recovery menu provides the following options:

1. Disable Continuous Update
2. Boot from Recovery Disk
3. Boot from Master Disk

Creating a Recovery Volume Using the Intel Matrix Storage Console

To create a recovery volume using the Intel Matrix Storage Console, the system must be configured in RAID mode with two drives. Boot the system into Microsoft Windows and open the Intel Matrix Storage Console application.

A recovery volume can be created in the Basic mode or the Advanced mode.

To create a recovery volume using the Basic mode, complete the following steps:

1. Select **Protect data using Intel® Rapid Recover Technology**.
2. A dialog box will pop up. Selecting **Yes** will start the volume creation process which can be monitored on the progress bar.

To create a recovery volume using the Advanced mode, complete the following steps:

1. Select **Advanced Mode** in the View menu.
2. Select **Create a Recovery Volume** in the Actions menu.
3. Select **Next** to continue.
4. Select the master disk and select **Next** to continue.
5. Select the recovery disk and select **Next** to continue.

6. Select the Update policy – **Continuous update** or **Update on request**.
7. Select **Finish** to complete the creation of the recovery volume.

The system will synchronize the master disk with the recovery disk once after the creation of the recovery volume.

Disk Synchronization Mode

There are two modes of updating or synchronizing the recovery disk with the master disk – either continuous update or manual update.

To change from Continuous Update mode to Update On Request mode using the Intel Matrix Storage Console, select the **Advanced mode** from the View menu, right-click on the recovery volume, and select **Disable Continuous Update**.

To change from Update On Request mode to Continuous update mode, complete the following steps:

1. Right-click on the recovery volume name and select **Modify Volume**.
2. Select **Next** on the Modify **Recovery Volume Wizard** dialog box to continue.
3. On the next screen, select **Continuous update**.
4. Select **Next** and then **Finish** to complete the operation.

Mounting the Recovery Disk



NOTE

Mounting the recovery disk will result in displaying the recovery disk in Microsoft Windows Explorer. The recovery disk contents will be write-protected to preserve data integrity with master disk.

To mount the mount the recovery disk, complete the following steps:

1. Make sure that the recovery volume is in **Update On Request** mode.
2. Then right-click on the recovery volume name and select **Access Recovery Drive Files**.
3. Select **OK** on the information dialog box.

The recovery disk will now be mounted and can be seen in Microsoft Windows Explorer.



NOTE

Individual files or folders can be copied from the recovery disk to the master disk. No write operations can be performed on the recovery disk.

To un-mount the recovery disk, complete the following steps:

1. In the Advanced mode, right-click on the recovery volume name.
2. Select **Access Recovery Drive Files**.
3. Select **OK** on the information dialog box.

The recovery disk is now un-mounted and reappears in Intel Matrix Storage Console.

A Error Messages and Indicators

Intel Desktop Board DQ45CB reports POST errors in two ways:

- By sounding a beep code
- By displaying an error message on the monitor

BIOS Beep Codes

The BIOS also issues a beep code (one long tone followed by two short tones) during POST if the video configuration fails (a faulty video card or no card installed) or if an external ROM module does not properly checksum to zero. Table 16 lists the BIOS codes.

Table 16. Beep Codes

Beep	Description
3	No memory
Siren	Processor overheat (on reboot)

BIOS Error Messages

When a recoverable error occurs during the POST, the BIOS displays an error message describing the problem. Table 17 gives an explanation of the BIOS error messages.

Table 17. BIOS Error Messages

Error Message	Explanation
PROCESSOR_THERMAL_TRIP_ERROR	Processor was previously shutdown due to a thermal event (overheating).
MULTI_BIT_ECC_ERROR	The firmware has detected that a Multi-Bit ECC Error occurred.
SINGLE_BIT_ECC_ERROR	The firmware has detected that a Single-Bit ECC Error occurred.
CMOS_BATTERY_ERROR	The firmware has detected that a CMOS battery failure occurred.
CMOS_CHECKSUM_ERROR	The firmware has detected that a CMOS Checksum Error occurred.
CMOS_TIMER_ERROR	The firmware has detected that the system date/time has not been set.
MEMORY_SIZE_DECREASE_ERROR	The firmware has detected that the system memory has decreased.
INTRUDER_DETECTION_ERROR	The system chassis was opened.
SPD_TOLER_ERROR	SERIAL PRESENCE DETECT (SPD) device data missing or inconclusive. Properly programmed SPD device data is required for reliable operation.
MEM_OPTIMAL_ERROR	The installed amount of memory in Channel A is not equal to the amount of memory in Channel B. Maximum memory performance is achieved with equal amounts of memory installed in each channel.

B Regulatory Compliance

This appendix contains the following regulatory compliance information for Intel Desktop Board DQ45CB:

- Safety standards
- European Union Declaration of Conformity statement
- Product Ecology statements
- Electromagnetic Compatibility (EMC) regulations
- Product certifications

Safety Standards

Intel Desktop Board DQ45CB complies with the safety standards stated in Table 18 when correctly installed in a compatible host system.

Table 18. Safety Standards

Regulation	Title
CSA/UL 60950-1, First Edition	Information Technology Equipment – Safety - Part 1: General Requirements (USA and Canada)
EN 60950-1:2006, Second Edition	Information Technology Equipment – Safety - Part 1: General Requirements (European Union)
IEC 60950-1:2005, Second Edition	Information Technology Equipment – Safety - Part 1: General Requirements (International)

Place Battery Marking

There is insufficient space on this Desktop Board to provide instructions for replacing and disposing of the Lithium ion coin cell battery. For system safety certification, the statement below or an equivalent statement is required to be permanently and legibly marked on the chassis near the battery.



CAUTION

Risk of explosion if the battery is replaced with an incorrect type. Batteries should be recycled where possible. Disposal of used batteries must be in accordance with local environmental regulations.

A suitable caution label is included with Intel Desktop Board DQ45CB.

For information about replacing the battery, go to page 55.

European Union Declaration of Conformity Statement

We, Intel Corporation, declare under our sole responsibility that the product Intel® Desktop Board DQ45CB is in conformity with all applicable essential requirements necessary for CE marking, following the provisions of the European Council Directives 2004/108/EC (EMC Directive) and 2006/95/EC (Low Voltage Directive).

The product is properly CE marked demonstrating this conformity and is for distribution within all member states of the EU with no restrictions.



This product follows the provisions of the European Directives 2004/108/EC and 2006/95/EC.

Čeština Tento výrobek odpovídá požadavkům evropských směrnic 2004/108/EC a 2006/95/EC.

Dansk Dette produkt er i overensstemmelse med det europæiske direktiv 2004/108/EC & 2006/95/EC.

Dutch Dit product is in navolging van de bepalingen van Europees Directief 2004/108/EC & 2006/95/EC.

Eesti Antud toode vastab Euroopa direktiivides 2004/108/EC ja 2006/95/EC kehtestatud nõuetele.

Suomi Tämä tuote noudattaa EU-direktiivin 2004/108/EC & 2006/95/EC määräyksiä.

Français Ce produit est conforme aux exigences de la Directive Européenne 2004/108/EC & 2006/95/EC.

Deutsch Dieses Produkt entspricht den Bestimmungen der Europäischen Richtlinie 2004/108/EC & 2006/95/EC.

Ελληνικά Το παρόν προϊόν ακολουθεί τις διατάξεις των Ευρωπαϊκών Οδηγιών 2004/108/EC και 2006/95/EC.

Magyar E termék megfelel a 2004/108/EC és 2006/95/EC Európai Irányelv előírásainak.

Icelandic Þessi vara stenst reglugerð Evrópska Efnahags Bandalagsins númer 2004/108/EC & 2006/95/EC.

Italiano Questo prodotto è conforme alla Direttiva Europea 2004/108/EC & 2006/95/EC.

Latviešu Šis produkts atbilst Eiropas Direktīvu 2004/108/EC un 2006/95/EC noteikumiem.

Lietuvių Šis produktas atitinka Europos direktyvų 2004/108/EC ir 2006/95/EC nuostatas.

Malti Dan il-prodott hu konformi mal-provvedimenti tad-Direttivi Ewropej 2004/108/EC u 2006/95/EC.

Norsk Dette produktet er i henhold til bestemmelsene i det europeiske direktivet 2004/108/EC & 2006/95/EC.

Polski Niniejszy produkt jest zgodny z postanowieniami Dyrektyw Unii Europejskiej 2004/108/EC i 2006/95/EC.

Portuguese Este produto cumpre com as normas da Diretiva Europeia 2004/108/EC & 2006/95/EC.

Español Este producto cumple con las normas del Directivo Europeo 2004/108/EC & 2006/95/EC.

Slovensky Tento produkt je v súlade s ustanoveniami európskych direktív 2004/108/EC a 2006/95/EC.

Slovenščina Izdelek je skladen z določbami evropskih direktiv 2004/108/EC in 2006/95/EC.

Svenska Denna produkt har tillverkats i enlighet med EG-direktiv 2004/108/EC & 2006/95/EC.

Türkçe Bu ürün, Avrupa Birliği'nin 2004/108/EC ve 2006/95/EC yönergelerine uyar.

Product Ecology Statements

The following information is provided to address worldwide product ecology concerns and regulations.

Recycling Considerations

As part of its commitment to environmental responsibility, Intel has implemented the Intel® Product Recycling Program to allow retail consumers of Intel's branded products to return used products to selected locations for proper recycling.

Please consult http://intel.com/intel/other/ehs/product_ecology for the details of this program, including the scope of covered products, available locations, shipping instructions, terms and conditions, etc.

中文

作为其对环境责任之承诺的部分，英特尔已实施 Intel Product Recycling Program（英特尔产品回收计划），以允许英特尔品牌产品的零售消费者将使用过的产品退还至指定地点作恰当的重复使用处理。

请参考http://intel.com/intel/other/ehs/product_ecology了解此计划的详情，包括涉及产品之范围、回收地点、运送指导、条款和条件等。

Deutsch

Als Teil von Intels Engagement für den Umweltschutz hat das Unternehmen das Intel Produkt-Recyclingprogramm implementiert, das Einzelhandelskunden von Intel Markenprodukten ermöglicht, gebrauchte Produkte an ausgewählte Standorte für ordnungsgemäßes Recycling zurückzugeben.

Details zu diesem Programm, einschließlich der darin eingeschlossenen Produkte, verfügbaren Standorte, Versandanweisungen, Bedingungen usw., finden Sie auf der http://intel.com/intel/other/ehs/product_ecology

Español

Como parte de su compromiso de responsabilidad medioambiental, Intel ha implantado el programa de reciclaje de productos Intel, que permite que los consumidores al detalle de los productos Intel devuelvan los productos usados en los lugares seleccionados para su correspondiente reciclado.

Consulte la http://intel.com/intel/other/ehs/product_ecology para ver los detalles del programa, que incluye los productos que abarca, los lugares disponibles, instrucciones de envío, términos y condiciones, etc.

Français

Dans le cadre de son engagement pour la protection de l'environnement, Intel a mis en œuvre le programme Intel Product Recycling Program (Programme de recyclage des produits Intel) pour permettre aux consommateurs de produits Intel de recycler les produits usés en les retournant à des adresses spécifiées.

Visitez la page Web http://intel.com/intel/other/ehs/product_ecology pour en savoir plus sur ce programme, à savoir les produits concernés, les adresses disponibles, les instructions d'expédition, les conditions générales, etc.

日本語

インテルでは、環境保護活動の一環として、使い終わったインテルブランド製品を指定の場所へ返送していただき、リサイクルを適切に行えるよう、インテル製品リサイクルプログラムを発足させました。

対象製品、返送先、返送方法、ご利用規約など、このプログラムの詳細情報は、http://intel.com/intel/other/ehs/product_ecology (英語)をご覧ください。

Malay

Sebagai sebahagian daripada komitmennya terhadap tanggungjawab persekitaran, Intel telah melaksanakan Program Kitar Semula Produk untuk membenarkan pengguna-pengguna runcit produk jenama Intel memulangkan produk terguna ke lokasi-lokasi terpilih untuk dikitar semula dengan betul.

Sila rujuk http://intel.com/intel/other/ehs/product_ecology untuk mendapatkan butir-butir program ini, termasuklah skop produk yang dirangkumi, lokasi-lokasi tersedia, arahan penghantaran, terma & syarat, dsb.

Portuguese

Como parte deste compromisso com o respeito ao ambiente, a Intel implementou o Programa de Reciclagem de Produtos para que os consumidores finais possam enviar produtos Intel usados para locais selecionados, onde esses produtos são reciclados de maneira adequada.

Consulte o site http://intel.com/intel/other/ehs/product_ecology (em Inglês) para obter os detalhes sobre este programa, inclusive o escopo dos produtos cobertos, os locais disponíveis, as instruções de envio, os termos e condições, etc.

Russian

В качестве части своих обязательств к окружающей среде, в Intel создана программа утилизации продукции Intel (Product Recycling Program) для предоставления конечным пользователям марок продукции Intel возможности возврата используемой продукции в специализированные пункты для должной утилизации.

Пожалуйста, обратитесь на веб-сайт http://intel.com/intel/other/ehs/product_ecology за информацией об этой программе, принимаемых продуктах, местах приема, инструкциях об отправке, положениях и условиях и т.д.

Türkçe

Intel, çevre sorumluluğuna bağlılığının bir parçası olarak, perakende tüketicilerin Intel markalı kullanılmış ürünlerini belirlenmiş merkezlere iade edip uygun şekilde geri dönüştürmesini amaçlayan Intel Ürünleri Geri Dönüşüm Programı'nı uygulamaya koymuştur.

Bu programın ürün kapsamı, ürün iade merkezleri, nakliye talimatları, kayıtlar ve şartlar v.s dahil bütün ayrıntılarını öğrenmek için lütfen http://intel.com/intel/other/ehs/product_ecology web sayfasına gidin.

Lead-free 2LI/Pb-free 2LI Board

The electronics industry is transitioning to European Union (EU) Restriction of Hazardous Substances (RoHS)-compliant products. The RoHS legislation restricts the use of six materials. One of these restricted materials is lead. Lead is the most common and problematic of the RoHS restricted materials.

There are exemptions in RoHS that allow the use of lead in some very limited locations in electronic products. Maximum lead concentration values have been established for RoHS-compliant electronic products that allow up to 1000 ppm of lead.

Lead-free/Pb-free is a nickname that is often used (or misused) for RoHS-compliant products. In this case, the term "Lead-free/Pb-free" means that lead has been removed where required by the RoHS legislation but still may exist as an impurity below 1000 ppm.

The term "Lead-free 2LI/Pb-free 2LI" means lead-free second level interconnect (2LI). The balls, leads, or pads used to connect the component to a printed circuit board are lead-free, but the first level interconnect (FLI) is not lead-free. The use of lead in the FLI is acceptable because of the RoHS "flip chip" or "die bump" interconnect exemption.

Intel Desktop Board DQ45CB is a lead-free second level interconnect product. Table 19 shows the lead-free second level interconnect marks as they appear on the board and accompanying collateral. These marks are based on JEDEC standard J-STD-609, "Marking and Labeling of Components, PCBs and PCBAs to Identify Lead, Lead Free and Other Attributes."

For more information concerning Intel's lead-free initiatives, refer to <http://intel.com/technology/silicon/leadfree.htm>.

Table 19. Lead-Free Second Level Interconnect Marks

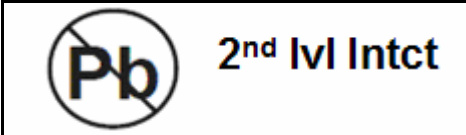
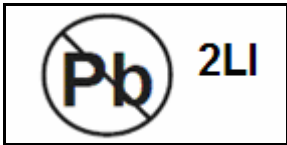
Description	Mark
<p>This symbol is used to identify electrical and electronic assemblies and components in which the Pb concentration level in the Desktop Board substrate and the solder connections from the board to the components (second-level interconnect) is not greater than 0.1% by weight (1000 ppm).</p>	<div style="text-align: center;">  <p>or</p>  <p>or</p>  </div>

Restriction of Hazardous Substances (RoHS)

EU RoHS

EU RoHS Directive 2002/95/EC restricts the use of the following six materials in various types of electronic and electrical equipment:

- Lead
- Mercury
- Cadmium
- Hexavalent chromium
- Polybrominated biphenyls (PBB)
- Polybrominated diphenyl ether (PBDE)

The maximum concentrations allowed are 0.1% or 1000 ppm (except for cadmium, which is limited to 0.01% or 100 ppm) by weight of homogeneous material.

Intel Desktop Board DQ45CB complies with these restrictions.

China RoHS

“China RoHS” is the term used by industry generally to describe legislation implemented by the Ministry of Information Industry (MII) in the People's Republic of China for the control of pollution by electronic information products (EIP). The official title of the China RoHS regulation is “Management Methods for Controlling Pollution by Electronic Information Products.”

China RoHS bans the same substances and has the same limits as EU RoHS. However, the China RoHS regulation requires specific product marking and a self-declaration of the controlled substances contained in each product.

Intel Desktop Board DQ45CB is a China RoHS-compliant product.

The required China RoHS mark indicates the product’s Environmental Friendly Usage Period (EFUP). The EFUP is defined as the number of years for which listed controlled substances will not leak or chemically deteriorate while in the product. The EFUP for Intel Desktop Boards has been determined to be 10 years.

The EFUP for Intel Desktop Board DQ45CB is shown in Table 20.

Table 20. China RoHS Environmentally Friendly Use Period Mark

Description	Mark
This is an example of the symbol used on Intel Desktop Boards and associated collateral. The color of the mark may vary depending upon the application. The Environmental Friendly Usage Period (EFUP) for Intel Desktop Boards has been determined to be 10 years.	

The China MII stipulates that a material Self Declaration Table (SDT) must be included in a product's user documentation. The SDT for Intel Desktop Board DQ45CB is shown in Figure 28.

关于符合中国《电子信息产品污染控制管理办法》的声明

Management Methods on Control of Pollution from
Electronic Information Products
(China RoHS declaration)

产品中有毒有害物质的名称及含量

部件名称 (Parts)	有毒有害物质或元素					
	铅 (Pb)	汞 (Hg)	镉 (Cd)	六价铬 (Cr6+)	多溴联苯 (PBB)	多溴二苯醚 (PBDE)
主板组件 Motherboard Assembly	x	o	o	o	o	o
<p>o : 表示该有毒有害物质在该部件所有均质材料中的含量均在 SJ/T 11363-2006 标准规定的限量要求以下。</p> <p>o : Indicates that this hazardous substance contained in all homogeneous materials of this part is below the limit requirement in SJ/T 11363-2006.</p> <p>x : 表示该有毒有害物质至少在该部件的某一均质材料中的含量超出 SJ/T 11363-2006 标准规定的限量要求。</p> <p>x : Indicates that this hazardous substance contained in at least one of the homogeneous materials of this part is above the limit requirement in SJ/T 11363-2006.</p> <p>对销售之日的所售产品,本表显示我公司供应链的电子信息产品可能包含这些物质。注意:在所售产品中可能会也可能不会含有所有所列的部件。</p> <p>This table shows where these substances may be found in the supply chain of our electronic information products, as of the date of sale of the enclosed product. Note that some of the component types listed above may or may not be a part of the enclosed product.</p>						

Figure 28. Intel Desktop Board DQ45CB China RoHS Material Self Declaration Table

EMC Regulations

Intel Desktop Board DQ45CB complies with the EMC regulations stated in Table 21 when correctly installed in a compatible host system.

Table 21. EMC Regulations

Regulation (Class B)	Title
FCC 47 CFR Part 15, Subpart B	Title 47 of the Code of Federal Regulations, Part 15, Subpart B, Radio Frequency Devices. (USA)
ICES-003 Issue 4	Interference-Causing Equipment Standard, Digital Apparatus. (Canada)
EN55022:2006	Limits and methods of measurement of Radio Interference Characteristics of Information Technology Equipment. (European Union)
EN55024:1998	Information Technology Equipment – Immunity Characteristics Limits and methods of measurement. (European Union)
EN55022:2006	Australian Communications Authority, Standard for Electromagnetic Compatibility. (Australia and New Zealand)
CISPR 22:2005 +A1:2005 +A2:2006	Limits and methods of measurement of Radio Disturbance Characteristics of Information Technology Equipment. (International)
CISPR 24:1997 +A1:2001 +A2:2002	Information Technology Equipment – Immunity Characteristics – Limits and Methods of Measurement. (International)
VCCI V-3/2007.04, V-4/2007.04	Voluntary Control for Interference by Information Technology Equipment (Japan)

Japanese Kanji statement translation: This is a Class B product based on the standard of the Voluntary Control Council for Interference from Information Technology Equipment (VCCI). If this is used near a radio or television receiver in a domestic environment, it may cause radio interference. Install and use the equipment according to the instruction manual.

この装置は、情報処理装置等電波障害自主規制協議会（VCCI）の基準に基づくクラスB情報技術装置です。この装置は、家庭環境で使用することを目的としていますが、この装置がラジオやテレビジョン受信機に近接して使用されると、受信障害を引き起こすことがあります。
取扱説明書に従って正しい取り扱いをして下さい。

Korean Class B statement translation: This is household equipment that is certified to comply with EMC requirements. You may use this equipment in residential environments and other non-residential environments.

이 기기는 가정용으로 전자파적합등록을 한 기기로서
주거지역에서는 물론 모든 지역에서 사용할 수 있습니다.

Ensure Electromagnetic Compatibility (EMC) Compliance

Before computer integration, make sure that the power supply and other modules or peripherals, as applicable, have passed Class B EMC testing and are marked accordingly.

Pay close attention to the following when reading the installation instructions for the host chassis, power supply, and other modules:

- Product certifications or lack of certifications
- External I/O cable shielding and filtering
- Mounting, grounding, and bonding requirements
- Keying connectors when mating the wrong connectors could be hazardous







If the power supply and other modules or peripherals, as applicable, are not Class B EMC compliant before integration, then EMC testing may be required on a representative sample of the newly completed computer.

Product Certifications

Board-Level Certification Markings

Intel Desktop Board DQ45CB has the product certification markings shown in Table 22.

Table 22. Product Certification Markings

Description	Mark
UL joint US/Canada Recognized Component mark. Includes adjacent UL file number for Intel Desktop Boards: E210882.	
FCC Declaration of Conformity logo mark for Class B equipment. Includes Intel name and DQ45CB model designation.	
CE mark. Declaring compliance to European Union (EU) EMC directive and Low Voltage directive.	
Australian Communications Authority (ACA) and New Zealand Radio Spectrum Management (NZ RSM) C-tick mark. Includes adjacent Intel supplier code number, N-232.	
Japan VCCI (Voluntary Control Council for Interference) mark.	
S. Korea MIC (Ministry of Information and Communication) mark. Includes adjacent MIC certification number: CPU-DQ45CB (B).	
Taiwan BSMI (Bureau of Standards, Metrology and Inspections) mark. Includes adjacent Intel company number, D33025.	
Printed wiring board manufacturer's recognition mark. Consists of a unique UL recognized manufacturer's logo, along with a flammability rating (solder side).	V-0

Chassis and Component Certifications

Ensure that the chassis and certain components; such as the power supply, peripheral drives, wiring, and cables; are components certified for the country or market where used. Agency certification marks on the product are proof of certification. Typical product certifications include:

In Europe

The CE marking signifies compliance with all applicable European requirements. If the chassis and other components are not properly CE marked, a supplier's Declaration of Conformity statement to the European EMC directive and Low Voltage directive (as applicable), should be obtained. Additionally, other directives, such as the Radio and Telecommunications Terminal Equipment (R&TTE) directive may also apply depending on product features.

In the United States

A certification mark by a Nationally Recognized Testing Laboratory (NRTL) such as UL, CSA, or ETL signifies compliance with safety requirements. Wiring and cables must also be UL listed or recognized and suitable for the intended use. The FCC Class B logo for home or office use signifies compliance with electromagnetic interference (EMI) requirements.

In Canada

A nationally recognized certification mark such as CSA or cUL signifies compliance with safety requirements. The Industry Canada statement at the front of this product guide demonstrates compliance with Canadian EMC regulations.

